

# **USER'S GUIDE**

Installation & Operation  
Instructions

Portable Doppler Flow Meter  
Model PDFM-IV  
Manual Series A.5

## **INDEX**

Quick Bench Test	3
Connections	3
Keypad System	4
Battery	4
Calibration Menu	4
Totalizer	6
Signal Strength	6
Password	7
Data Logger	8
RS232 Serial Output	12
'Greyline Logger' Software	13
Units Selection	14
Calibration Mode	14
4-20mA Output	15
Damping	15
Special Functions	15
Sensor Mounting	16
Error/Warning Messages	20
Troubleshooting	20
Warranty	24
Applications Hotline	25
Product Return Procedure	25
Appendix A - Options	26
Appendix B Conversion Tables	27
Pipe Charts	29

*IMPORTANT NOTE: This instrument is manufactured and calibrated to meet product specifications. Please read this manual carefully before installation and operation. Any unauthorized repairs or modifications may result in a suspension of the warranty.*

*Disponible en français  
Available in Adobe Acrobat pdf format*

**QUICK BENCH TEST:**

Connect Sensor and press . Test operation of the PDFM-IV by holding the sensor in one hand and rubbing your thumb or fingers briskly across the face (plastic surface) of the sensor. Allow 15 seconds for the PDFM-IV to process the signal and display a flow value.

**CONNECTIONS:**

**POWER INPUT:** The PDFM-IV requires 100-130VAC /200-260VAC 50/60Hz for the internal battery charger. The PDFM-IV also accepts 12VDC power input applied to the 12VDC connector on the instrument front panel.

FRONT PANEL

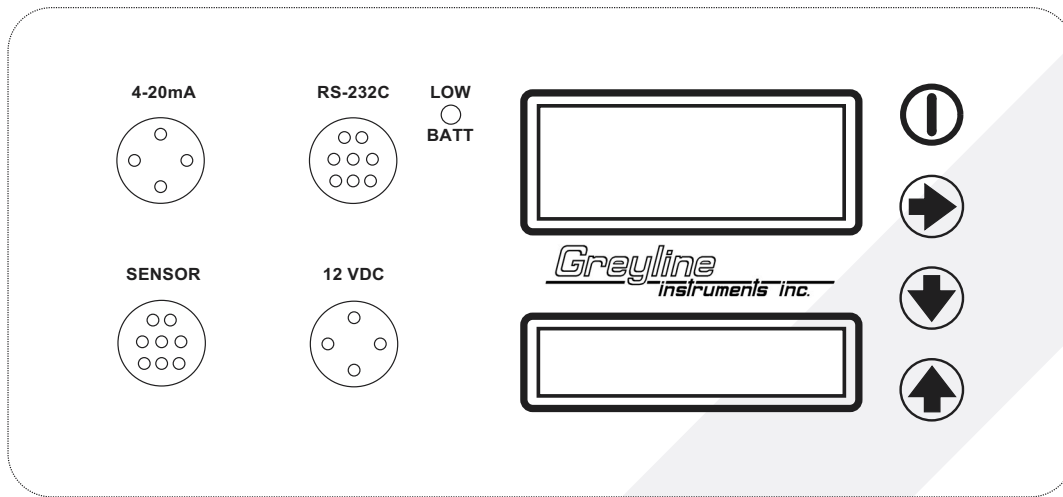

A set of cables and plugs are supplied with each PDFM-IV. Plugs are factory-wired and labeled to match Front Panel Sockets.

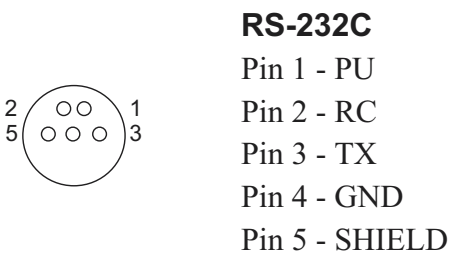
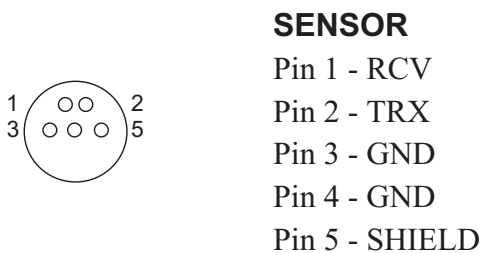
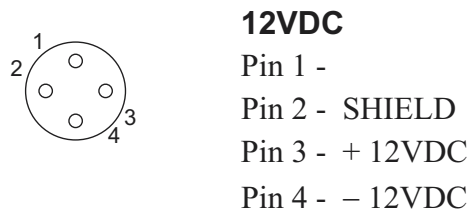
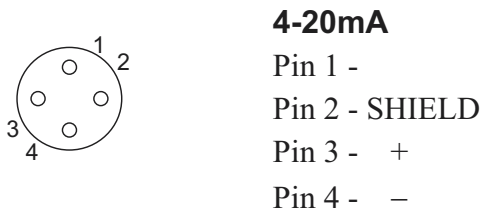

## KEYPAD SYSTEM

Pressing the top key  turns the flowmeter ON and OFF.

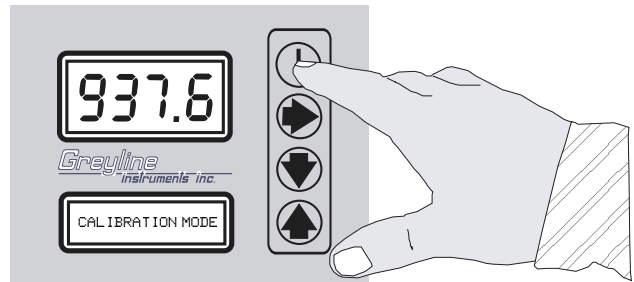

The PDFM-IV has a simple 3-button calibration system. Operating and calibration modes are shown on the 16-digit alphanumeric display. The keypad is used to move around the menu to calibrate the PDFM-IV, and to view operating mode and functions. If the keypad is not used for 10 minutes, the PDFM-IV will automatically go to RUN mode. Use the keypad to explore the Menu and become familiar with its features.





## LOW BATTERY

The PDFM-IV will operate for approximately 8 hours when its internal battery is fully charged. It will automatically switch off when the battery is discharged. If the PDFM-IV is switched on again before recharging the LOW-BATT light will come on and the flowmeter will operate for a short time before switching off again. Allow 6 hours to fully recharge the internal battery from an AC power source. The PDFM-IV can be operated while recharging and it is protected from overcharge.

## CALIBRATION MENU

The following diagram shows the PDFM-IV Menu system. Arrows show the three directions to leave a box. Pressing a corresponding keypad arrow will move to the next box in the direction shown. Move the cursor (or underline) under numerals to increase or decrease the number with the   keys.

At the bottom of each Menu column is a STORE? YES box. To store the calibration values permanently (even through power failure), move the cursor under YES and press the  or  key. If the  key is pressed with the cursor under STORE? no changes will be stored and the system will return to the top of the Menu column.

**CALIBRATION MENU CHART**

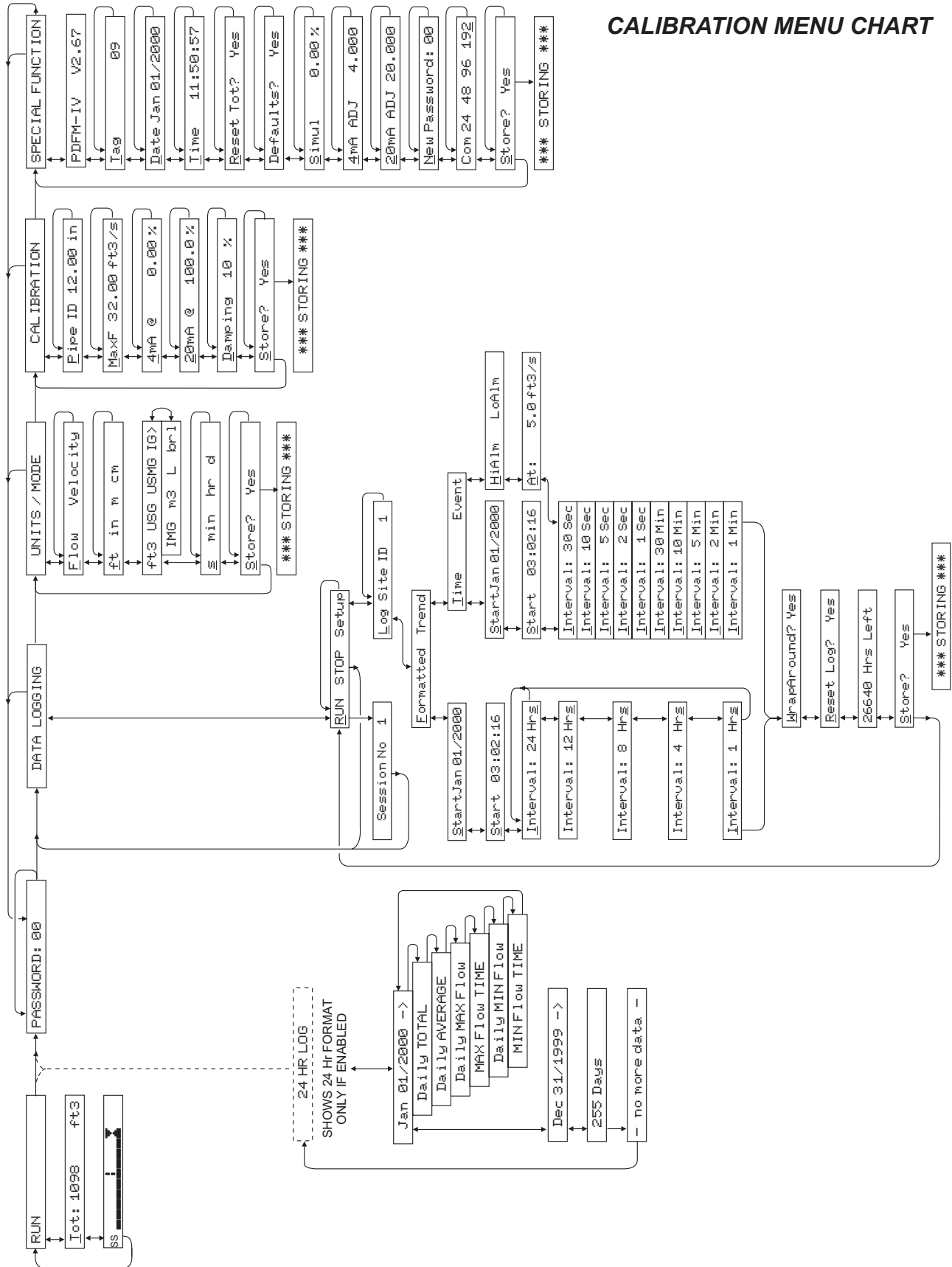

**RUN**

A scrolling display shows the units selected from the UNITS/MODE column, the mode of operation (VELOCITY or FLOW), the full scale value for the large numeric display and the TOTALIZER value.

When the flow rate exceeds 4 digits on the large LCD display the PDFM-IV will automatically insert a decimal point and the lower display will scroll to show a multiplier (eg: flow of 12371 USG/d will be displayed as 12.37 and the lower display will scroll to show DISPLAY UNITS: US gal/d X 1000).

**TOTALIZER**

From DISPLAY UNITS press ↓ key to display the totalizer. The Totalizer value is updated every 2 seconds with flow volume > 1 litre (0.264 USG). The Totalizer display will show up to 10 digits and then overflows to 0 automatically.

Units: ft<sup>3</sup>, USG, IG, L

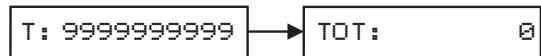

Units = m<sup>3</sup>

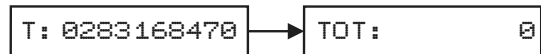

Press ↑ key to return to DISPLAY UNITS.

The totalizer can be reset by going → to SPECIAL FUNCTIONS and ↓ to RESET TOT?.

**SIGNAL STRENGTH**

<p>From TOTALIZER use ↓ key to get to SS (Signal Strength / Sensitivity).</p>	<p>The diagram shows a horizontal bar representing the signal strength scale. On the left is 'SS'. A solid black bar (Current Signal Strength Arrow) is positioned at a low level. A vertical dashed line (Minimum Marker) is in the middle. A vertical solid line (Ideal Marker) is on the right. Arrows point from labels 'Current Signal Strength Arrow', 'Minimum Marker', and 'Ideal Marker' to their respective elements.</p>
<p>Press → to position the cursor under the numeral. Use ↑ or ↓ to increase or decrease signal strength. Minimum setting is '1' Maximum setting is '9'.</p>	<p>The diagram shows the same horizontal bar as above, but the 'Current Signal Strength Arrow' is now positioned under the numeral '5'.</p>
<p>Signal strength should be adjusted so that the 'Signal Strength Arrow' meets the 'Ideal Marker' under flow conditions.</p>	<p>The diagram shows the 'Current Signal Strength Arrow' extended to meet the 'Ideal Marker'.</p>
<p>Signal strength must pass the 'Minimum Marker' for the flow meter to display flow.</p>	<p>The diagram shows the 'Current Signal Strength Arrow' extended past the 'Minimum Marker'.</p>
<p>It is normal for Signal Strength to fluctuate and rise to full scale under high flow conditions.</p>	<p>The diagram shows the 'Current Signal Strength Arrow' extended to the full scale of the horizontal bar.</p>

## **PASSWORD**

The password (a number from 00 to 99) prevents unauthorized access to the CALIBRATION menu.

From RUN press **➡** to PASSWORD.

Press **➡** to place the cursor under the digit and **⬇** or **⬆** to change the number. Factory default Password is 00.

A new password can be stored by going **➡** to SPECIAL FUNCTIONS and **⬇** to NEW PASSWORD.

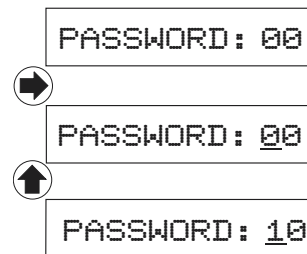

**DATA LOGGER**

**MENU**

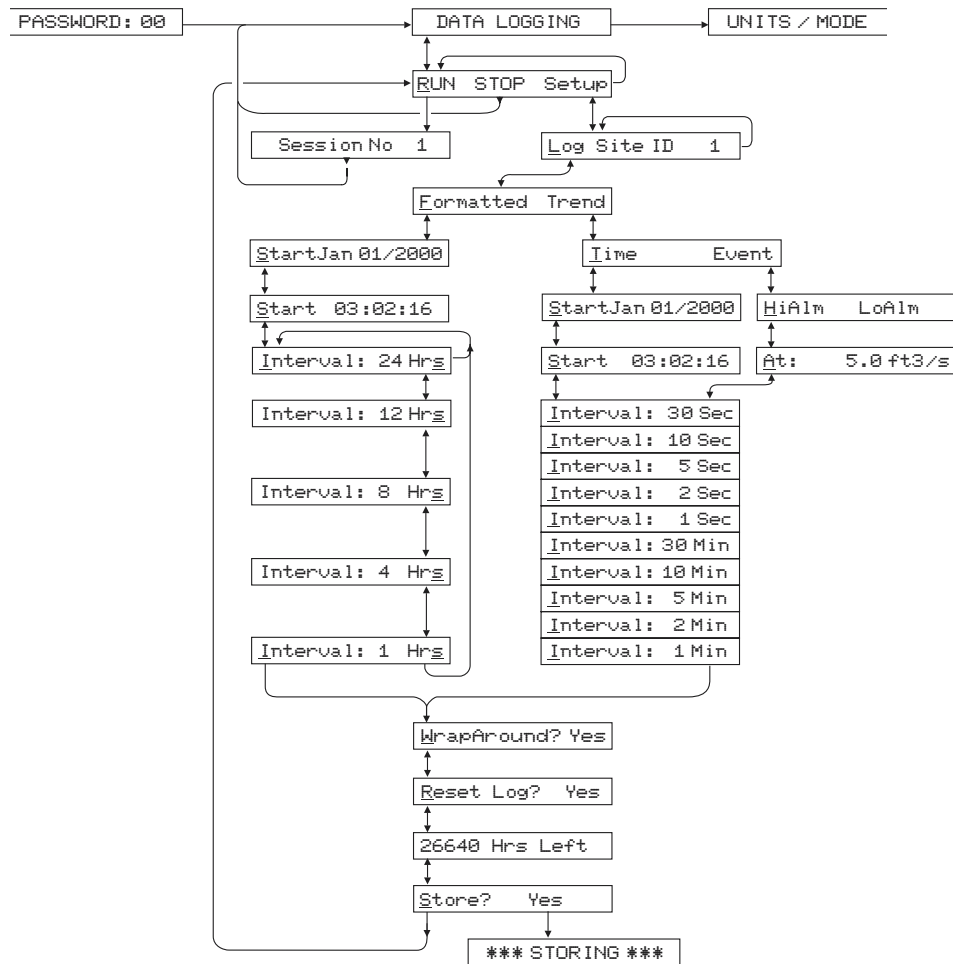

**Data Logger Setup**

From RN STOP SETUP press **➡** to SETUP and then **⬇** to Log Site ID 0. Press **➡** to position the cursor under the numeral and **⬇** or **⬆** to change the numerals. The “Site ID” number is retained with data logging sessions to identify logs stored from different locations.

## Formatted Data

Press ↓ from Log Site ID and press ↓ from Formatted.

“Formatted” data stores a summary of flow readings over a user-selectable time period. The summary includes:

DATE and TIME  
Interval TOTAL  
Interval AVERAGE  
Interval MAX FLOW  
Interval MAX FLOW TIME  
Interval MIN FLOW  
Interval MIN FLOW TIME

From Formatted press ↓ to Start MMM DD/YYYY (eg: Jan 01/2000). Press → to position the cursor and then ↓ or ↑ to set the Month, Day and Year that logging will Start. Press → to return to Start.

Press ↓ to Start (time) and → to position the cursor under the time column HH/MM/SS (24 hour clock in Hours/minutes/seconds, eg: 23:02:16) and then ↓ or ↑ to set the logging start Time. Press → to return to Start.

Press ↓ to Interval and → to the Hrs column. Press ↓ or ↑ to select the flow logging interval. Choose from:

24 Hrs, or 12 Hrs, or 8 Hrs, or 4 Hrs, or 1 Hrs

Press → to return to Interval. Press ↓ and the PDFM-IV will report xxxxx Hrs Left indicating the amount of logging time available with your current set-up. You can also press ↑ to return to previous menu items and make changes.

Press ↓ to WrapAround Yes?. Press → to Yes? and ↓ to enable the logging wrap function. In WrapAround mode the *oldest* data will be overwritten by the *newest*. If WrapAround is not enabled the logger will stop when its memory becomes full.

Press ↓ to Reset Log? Yes. Press → to Yes and then ↓ to reset the Log and erase all previous sessions and stored values. Or press ↓ from Reset Log? to retain existing data in the Log. The PDFM-IV will display “xxxxx Hrs/Days Left”.

From the xxxxx Hrs Left display press ↓ to Store? Yes. Press → to Yes and then ↓ to save your Data Logging setup, or press ↓ from Store? to cancel changes made above and exit without storing changes.

From the Data Logging Store? Yes prompt the menu will return to RUN STOP SETUP. Press **➡** to position the cursor under RUN and press **⬇** to activate the Data Logger to start at your selected start Date and Time. The PDFM-IV will display SESSION NO. x. Press **⬇** to return to DATA LOGGING.

**Viewing FORMATTED Data Logs on the PDFM-IV Display**

24 Hour Formatted logs can be viewed directly on the PDFM-IV display. From RUN press **➡** to 24 HR LOG. This function is available only if 24 Hour Formatted logging has been Stored from the DATA LOGGING menu.

The 24 Hour Log Report is designed to be read one line at time using the **➡** key. Using the **⬇** or **⬆** keys will return the display to the Date column.

TODAYS DATE	DAILY TOTAL	DAILY AVERAGE	MAX FLOW	MAX FLOW TIME	MIN FLOW	MIN FLOW TIME
PREVIOUS DATE	"	"	"	"	"	"
PREVIOUS DATE	"	"	"	"	"	"
PREVIOUS DATE	"	"	"	"	"	"
PREVIOUS DATE	"	"	"	"	"	"
PREVIOUS DATE	"	"	"	"	"	"

The current day plus the past 255 days of data can be displayed. (Greyline Logger software will display up to 1300 days of data.)

**Trend Data Logging - Setup**

From RUN STOP SETUP press **➡** to SETUP and then **⬇** to Log Site ID 0. Press **➡** to position the cursor under the numeral and **⬇** or **⬆** to change the numerals. The "Site ID" number is retained with data logging sessions to identify logs stored from different locations.

From Log Site ID press **⬇** to Formatted Trend and press **➡** to position the cursor under Trend. Then press **⬇** to select Time based logging.

**'Time' based Trend Logging**

Time based logging allows you to choose Start and Stop times and a logging interval.

From Time press **⬇** to Start MMM DD/YYYY (eg: Jan 01/2000). Press **➡** to position the cursor and then **⬇** or **⬆** to set the Month, Day and Year that logging will Start. Press **➡** to return to Start.

Press **⬇** to Start (time) and **➡** to position the cursor under the time column HH/MM/SS (24 hour clock in Hours/minutes/seconds, eg: 23:02:16) and then **⬇** or **⬆** to set the logging start Time. Press **➡** to return to Start.

Press **↓** to Interval and **→** to the Sec/Min column. Press **↓** or **↑** to set the logging time interval.  
Choose:

30 Sec	30 Min
10 Sec	10 Min
5 Sec	5 Min
2 Sec	2 Min
1 Sec	1 Min

Press **→** to return to Interval and **↓** to Reset Log? To erase all existing data in the log press **→** to Yes and **↓**. To keep existing data in the Log press **↓** from Reset Log? If you have made changes to the Start Date, Time or Interval, the data logger will automatically start a new “session”. The PDFM-IV will display “xxxxx Hrs/Days Left”.

From the xxxxx Hrs Left display press **↓** to Store? Yes. Press **→** to Yes and then **↓** to save your Data Logging setup, or press **↓** from Store? to cancel changes made above and exit without storing changes.

From the Data Logging Store? Yes prompt the menu will return to RUN STOP SETUP. Press **→** to position the cursor under RUN and press **↓** to activate the Data Logger to start at your selected start Date and Time. The PDFM-IV will display SESSION NO. x. Press **↓** to return to DATA LOGGING.

### ***‘Event’ based Trend Logging***

Event based logging stores data points only when a High or Low flow set point has been reached.

With cursor under Event press **↓** to HiAlm LoAlm. HiAlm will log points *above* a selectable flow rate, while LoAlm will log points *below* a selectable flow rate. Position the cursor under HiAlm or LoAlm and press **↓** to the At: prompt. Press **→** to the numerals column and press **↓** or **↑** to set flow alarm logging set point. Press **→** to return to At:.

Press **↓** to Interval and **→** to the Sec/Min column. Press **↓** or **↑** to set the logging time interval.

Choose:

30 Sec	30 Min
10 Sec	10 Min
5 Sec	5 Min
2 Sec	2 Min
1 Sec	1 Min

Press **→** to return to Interval and press **↓** to Reset Log? To erase all existing data in the log press **→** to Yes and **↓**. To keep existing data in the Log press **↓** from Reset Log? If you have made changes

to the Start Date, Time or Interval, the data logger will automatically start a new "session". The PDFM-IV will display "xxxxx Hrs/Days Left".

From the xxxxx Hrs Left display press ↓ to Store? Yes. Press → to Yes and then ↓ to save your Data Logging setup, or press ↓ from Store? to cancel changes made above and exit without storing changes.

From the Data Logging Store? Yes prompt the menu will return to RUN STOP SETUP. Press → to position the cursor under RUN and press ↓ to activate the Data Logger to start. The PDFM-IV will display SESSION NO. x. Press ↓ to return to DATA LOGGING.

**Logging "Sessions"**

Each time you select STOP in the DATA LOGGING menu, the Data Logger stores the current data in memory as a "SESS ION NO" automatically numbered from "1" to "10". If you resume logging by selecting RUN, the Data Logger will report that a new logging session is started and titled "SESS ION NO xx". When you download the logger files to your PC using Greyline Logger software, each Session will open as a separate graph/table titled "Greyline Data Log xx".

Important:

If you STORE instrument calibration changes under the UNITS/MODE or CAL IBRATON menus, STOP the data logger and select RUN again to start a new logging Session with your new calibration values.

**Data Retrieval via RS232 serial output**

Output connector is DB9-Female. Use the cable supplied for connection to a PC computer. Use the cable and optional Null Modem NM-DB9M/DB25M for connection to a modem.

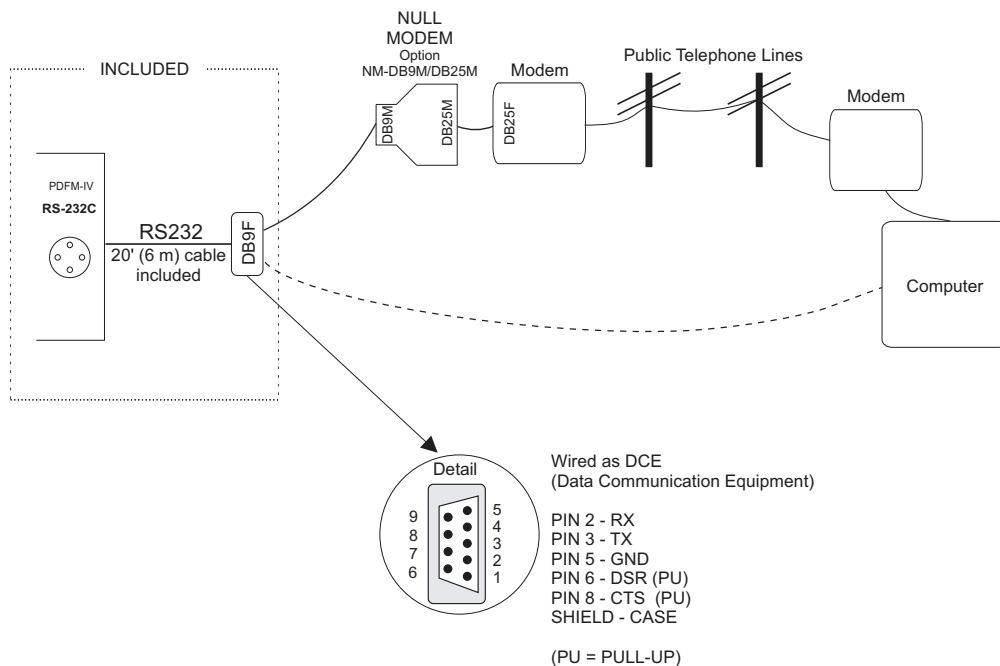

**'GREYLINE LOGGER' SOFTWARE FOR WINDOWS**

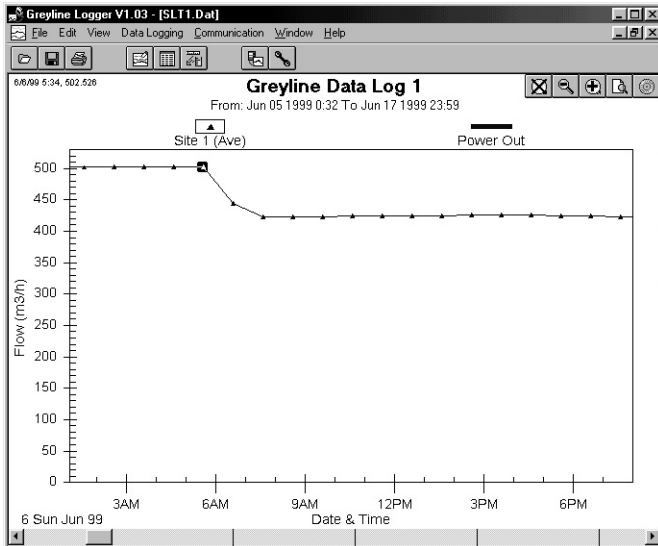

Run 'Greyline Logger' software for Windows 95 (98 or NT) to retrieve stored logs.

Manual for Greyline Logger software is under the 'Help' drop-down menu.

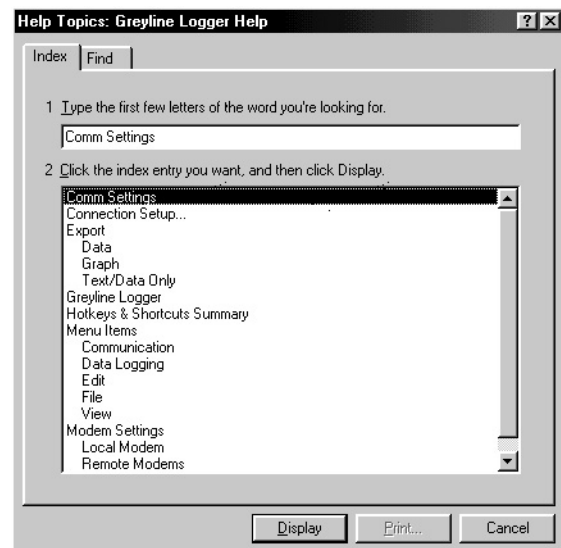

Baud rate may be changed on the PDFM-IV under the SPECIAL FUNCTIONS menu. Factory default is 19200 baud. Baud rate set through Greyline Logger software must match the baud rate set on the PDFM-IV.

## UNITS SELECTION

Use **➡** to get to UNITS SELECTION, then **⬇** to get to Linear Units. Use **➡** to move the cursor under the required units.

Use **⬇** to get to Volume Units and use **➡** to move the cursor under the required units.

ft3	=	Cubic Feet
USG	=	US Gallons
USMG	=	US Million Gallons
IG	=	Imperial Gallons
IMG	=	Imperial Million Gallons
m3	=	Cubic Meters
L	=	Liters
brl	=	Barrels (42 USG)

Use **⬇** to get to units of Time then **➡** to move the cursor under the required units (per second, minute, hour or day). Press **⬇**.

Use **➡** to select VELOCITY or FLOW.

VELOCITY mode displays flow velocity in units/time (ft/sec, or m/sec).

FLOW mode displays flow rate in engineering units (e.g. gpm, litres/sec etc.).

When all units have been selected go to STORE? then **➡** to YES and **⬇** or **⬆** to CALIBRATION MODE.

## CALIBRATION MODE

Press **⬇** to P I P E I D and **➡** to place the cursor under the digits and **⬇** or **⬆** to change the numbers and decimal point. Pipe ID should be entered as the exact inside diameter of the pipe where the sensor is mounted.

Press **➡** to return the cursor to P I P E I D and **⬇** to M A X F L O W. Set digits to the maximum flow rate. If maximum flow is unknown, enter an estimated maximum and observe actual flow to determine the correct maximum value (MaxF entry is required *only* to set 20mA output at a specific flow rate and maximum flow in the data logger. MaxF setting has no effect on the PDFM-IV digital display, totalizer, or control relays).

## 4-20mA CURRENT LOOP

The 4-20mA output can be offset so that 4mA or 20mA correspond to flow rates other than Zero and Maximum.

**4mA @** . Use **↓** or **↑** to set % output for 4mA. It is adjustable from -5% (3.8mA) up to 15% lower than the 20mA setting. Adjustment resolution is 0.05% (0.01mA).

**20mA @** . Use **↓** or **↑** to set % output for 20mA (down to 15% greater than the 4mA setting and up to 300%). Adjustment resolution is 0.05% (0.01mA).

## DAMPING

Increase damping to stabilize readings under turbulent flow conditions. Decrease damping for fast response to flow changes. Damping time shown in percentage is the interval for a zero to full scale display change (maximum 99 percent). Factory default is 20 percent.

## SPECIAL FUNCTIONS

PDFM-IV V	shows software version installed
Tag	enter instrument Tag Number (0-9999)
Date	use the <b>↓</b> or <b>↑</b> keys to change date as required
Time	use the <b>↓</b> or <b>↑</b> keys to change time as required
Reset Tot? Yes	Select <u>Y</u> es to reset totalizer
Defaults? Yes	Press <b>➡</b> 3 times to select <u>Y</u> es. Store to erase <u>all</u> user settings and return instrument to factory settings.
Simul 0.00%	exercises 4-20mA output, digital display and control relays. Simplifies calibration of remote devices on the 4-20mA loop and checks set point/operation of Relays calibrated in Flow mode. Go <b>↓</b> for 100%.
4mA ADJ	Use to fine tune the 4mA and 20mA calibration of the 4-20mA output. Adjustment range is +1mA to -1mA in 0.002mA steps
20mA ADJ	<u>Important</u> : The 4-20mA output will be forced to 4mA and 20mA respectively during these adjustments.
New Password	position cursor under digits and set new number between 00 and 99
Com 24 48 96 192	Set the baud rate of the PDFM-IV RS232 output

## SENSOR MOUNTING LOCATION

The position of the sensor is one of the most important considerations for accurate Doppler flow measurement. The same location guidelines apply to Doppler as most other types of flow meters.

Before permanently mounting a Doppler sensor onsite testing is recommended to determine optimum mounting position. Use the sensor coupling compound (supplied with each Greyline flow meter, or petroleum gel, acoustic compound or electrocardiograph gel). Take several readings around the axis of the pipe and then at several points upstream and downstream from the selected position, checking for consistent readings. Avoid high or low reading areas. Mount the sensor where consistent (average) readings were obtained or continue testing on another pipe section.

**VERTICAL OR HORIZONTAL PIPE -** Vertical pipe runs generally provide evenly distributed flow. On Horizontal pipes and liquids with high concentrations of gas or solids, the sensor should be mounted on the side (3 or 9 o'clock position) to avoid concentrations of gas at the top of the pipe, or solids at the bottom. For liquids with minimal gas bubbles (e.g. potable water) the sensor should be mounted on the top of a horizontal pipe (12 o'clock position) to obtain the best signal strength.

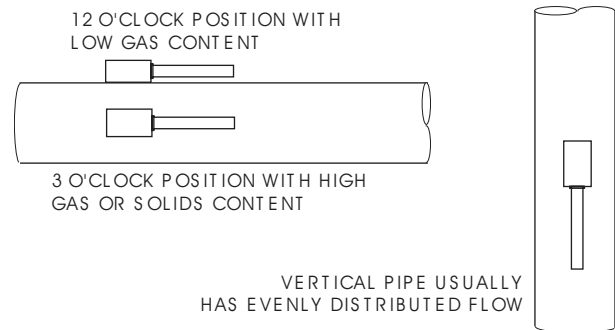

**VELOCITY INCREASING DEVICES:** Generally the sensor must be mounted away from flow disturbances such as valves, pumps, orifice plates or venturis which tend to increase flow velocity or cause cavitation. Velocity increasing devices often cause cavitation and readings both up and downstream may show much higher velocity. As a guideline, mount the sensor 20 diameters upstream and 30 diameters downstream from velocity increasing devices.

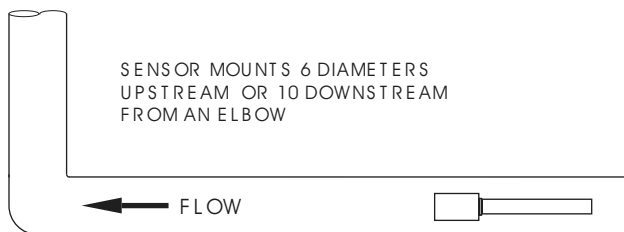

**TURBULENCE INCREASING DEVICES:** Elbows, flanged connections and tees tend to introduce desirable conditions of an evenly distributed flow profile with some air or gases entrained in the flow. Sensor mounting 6 pipe diameters upstream and 10 diameters downstream from these disturbances is generally optimum.

The transducer is designed to mount longitudinally on a straight section of pipe. Do not attempt to mount it on bends, elbows or fittings.

### SENSOR MOUNTING

Prepare an area 2" wide by 4" long (50mm x 100mm) for sensor bonding by removing all paint, scale and rust. The objective of site preparation is to eliminate any discontinuity between the sensor and the pipe wall, which would prevent acoustical coupling.

A PC3 Coupling Compound Kit is supplied with each Greyline flow meter. It includes recommended water soluble coupling compound in a plastic applicator.

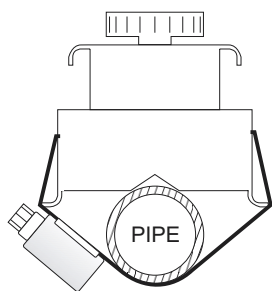

END VIEW

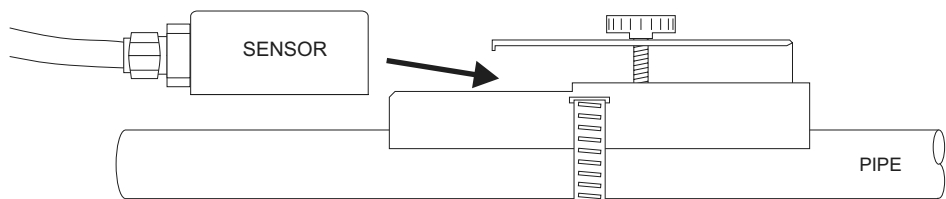

Mount the PC3 pipe clamp as illustrated on pipes 0.6" / 15 mm OD or larger. Stainless steel bands are included for mounting on pipes up to 32" / 81 cm OD.

Additional stainless steel bands (by customer) may be combined to mount on pipes up to 180" / 4.5 m OD.

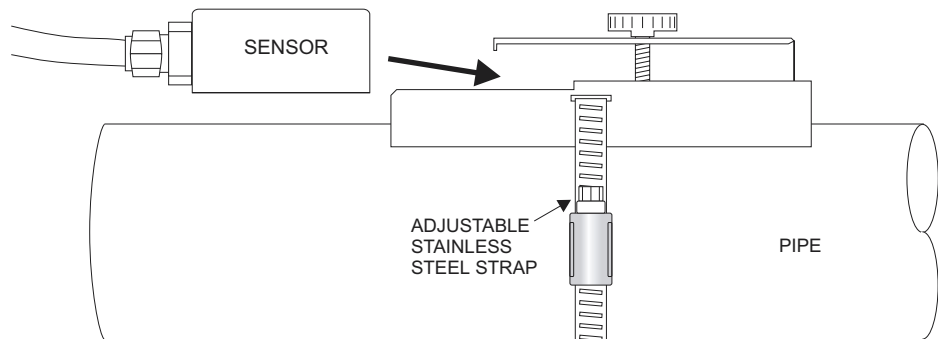
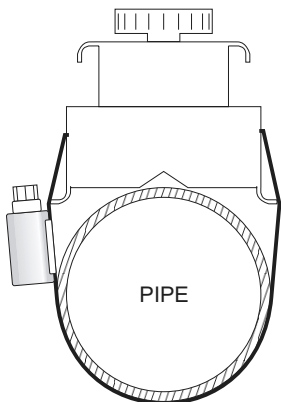

## **SENSOR COUPLING**

For permanent or temporary bonding, the following are recommended:

- a) Ultrasonic Couplant (supplied), water soluble - Greyline Part #CC30
- b) Dow Corning silicon compound #4 (for semi-permanent mounting) - Greyline Part #CC
- c) Electrocardiograph gel or Petroleum gel

The above are arranged in their order of preferred application.

'c' are only good for room temperature application.

DO NOT USE: Silicon RTV compound (silicon rubber).

Use the PC3 pipe clamp (supplied) as illustrated or use a loop of electrical tape for temporary mounting. Apply coupling compound to the coloured face of the sensor. A bead, similar to toothpaste on a toothbrush, is ideal. Do not overtighten (crush the sensor).

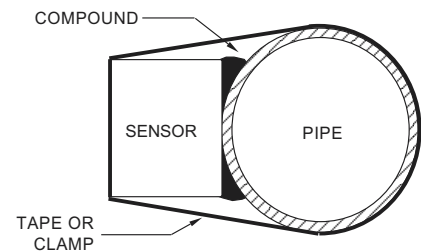
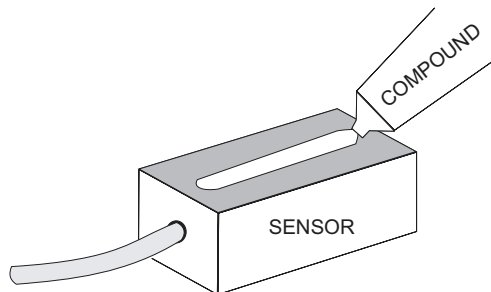

The sensor must be fixed securely to the pipe with coupling material between the sensor face and the pipe. Sensor installation with excessive coupling compound can result in gaps or voids in the coupling and cause errors or loss of signal. Insufficient coupling compound will create similar conditions.

Over time temporary coupling compounds (e.g. water soluble compound or Petroleum Gel) may gradually sag or wash away from the sensor resulting in reduced signal strength and finally complete loss of signal. Warm temperatures, moisture and vibration will accelerate this process. Dow Corning Silicone Compound #4 (Greyline Option CC) is recommended for semi-permanent installations.

**SENSOR MOUNTING/COUPLING RECOMMENDATIONS**

**BAD**

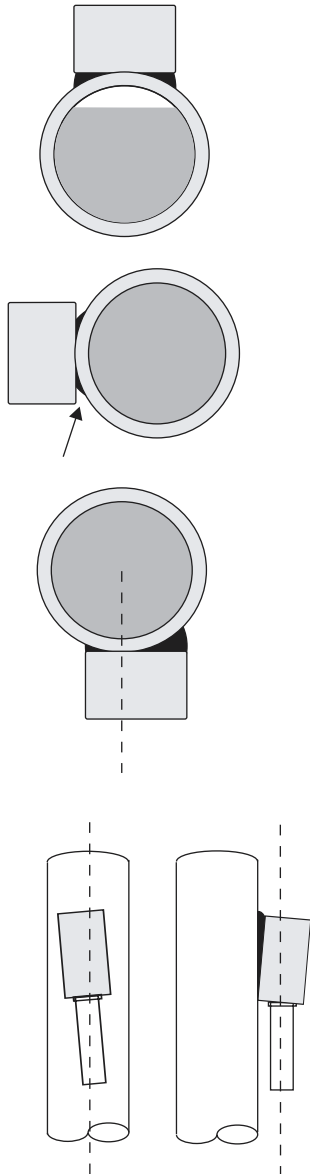

**GOOD**

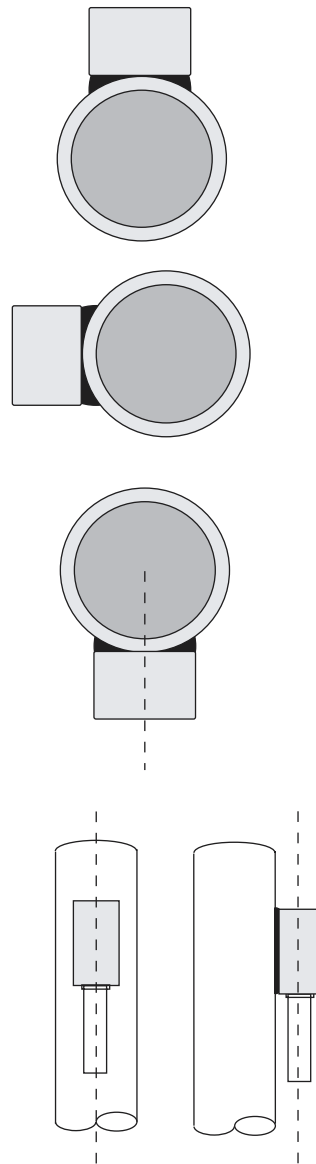

**ERROR/WARNING MESSAGES**

- E: ILLEGAL I.D.**            The value entered for **PIPE ID** must be greater than 0.5 inch (1.27 cm) and less than 180 inches (457.2 cm).
- E: ILLEGAL MaxF**        The value entered for **MaxF** (maximum flow) is too low or too high. Maximum flow value must compute (using pipe ID) a velocity greater than 0.25 ft/sec (0.076 m/sec) or less than 40.0 ft/sec (12.2 m/sec). Refer to Appendix B - Conversion Tables to convert from volume to velocity units.
- ERROR: ILLEGAL SETPOINTS**    On or off point > Max Flow / Max Velocity
- !!MEM CORRUPTED!**        The PDFM-IV must be Reset and Recalibrated. Reset procedure: Reset will clear all memory including the data logger. The PDFM-IV will need recalibration after this procedure. Press and hold **↓** and **↑** keys at the same time until the instrument displays **\*Memory Reset\***.

**FIELD TROUBLESHOOTING**

<i>Possible Causes:</i>	<i>Corrective Action:</i>
<b>METER READING LOWER THAN EXPECTED</b>	
<ul style="list-style-type: none"> <li>• Calibration error</li> </ul>	<input type="checkbox"/> Review <b>UNITS SELECTION</b> menu and <b>Pipe ID</b>
<ul style="list-style-type: none"> <li>• Lower flow rate than expected</li> </ul>	<input type="checkbox"/> Investigate pump/valves. Compare velocity with alternative instrument
<ul style="list-style-type: none"> <li>• Signal not penetrating far enough into the pipe</li> </ul>	<input type="checkbox"/> Increase sensitivity <input type="checkbox"/> Relocate sensor closer to elbows or flow disturbances
<ul style="list-style-type: none"> <li>• Laminar flow condition or high solids/bubbles content in liquid</li> </ul>	<input type="checkbox"/> Remount Sensor at 12 o'clock position on horizontal pipe
<ul style="list-style-type: none"> <li>• Improper mounting of sensor</li> </ul>	<input type="checkbox"/> Reinstall Sensor with careful application of Coupling Compound
<b>METER READING WHEN THERE IS NO FLOW</b>	
<ul style="list-style-type: none"> <li>• Vibration on pipe</li> </ul>	<input type="checkbox"/> Install in another location
<ul style="list-style-type: none"> <li>• Local electrical noise</li> </ul>	<input type="checkbox"/> Reduce sensitivity <input type="checkbox"/> Test at a different location
<ul style="list-style-type: none"> <li>• Cross talk between two or more Doppler flowmeters</li> </ul>	<input type="checkbox"/> Turn OFF one flowmeter

<i>Possible Causes:</i>	<i>Corrective Action:</i>
<i>METER READING WHEN THERE IS NO FLOW</i>	
<ul style="list-style-type: none"> <li>• Variable Speed Drive interference</li> </ul>	<input type="checkbox"/> Follow Drive manufacturers wiring and Grounding instructions <input type="checkbox"/> Relocate Flowmeter electronics, Sensor and wiring away from VSD
<i>NO FLOW INDICATION</i>	
<ul style="list-style-type: none"> <li>• SIGNAL STRENGTH Sensitivity set too low</li> </ul>	<input type="checkbox"/> Increase SIGNAL STRENGTH Sensitivity
<ul style="list-style-type: none"> <li>• Not enough suspended particles or gases in the fluid</li> </ul>	<input type="checkbox"/> Mount Sensor at 12 o'clock position on horizontal pipe
<ul style="list-style-type: none"> <li>• Coupling compound washed out, or sensor loose on pipe</li> </ul>	<input type="checkbox"/> Remount sensor <input type="checkbox"/> Use Dow Corning Silicone #4
<ul style="list-style-type: none"> <li>• Power interruption. No flow</li> </ul>	<input type="checkbox"/> Check low battery. Confirm flow
<i>METER READING TOO HIGH</i>	
<ul style="list-style-type: none"> <li>• Calibration error</li> </ul>	<input type="checkbox"/> Review UNITS SELECTION menu and Pipe ID
<ul style="list-style-type: none"> <li>• Vibration or noise on the pipeline</li> </ul>	<input type="checkbox"/> Decrease Sensitivity. Install in another location.
<ul style="list-style-type: none"> <li>• Nearby velocity increasing device (pump, valve, orifice plate)</li> </ul>	<input type="checkbox"/> Relocate sensor >30 pipe diameters from velocity increasing device
<ul style="list-style-type: none"> <li>• Local electrical noise</li> </ul>	<input type="checkbox"/> Test at a different location
<ul style="list-style-type: none"> <li>• Variable Speed Drive interference</li> </ul>	<input type="checkbox"/> Follow Drive manufacturers wiring and Grounding instructions <input type="checkbox"/> Relocate Flowmeter electronics, Sensor and wiring away from VSD
<i>METER READING ERRATIC</i>	
<ul style="list-style-type: none"> <li>• Sensor mounted too close to valve, pump or elbow</li> </ul>	<input type="checkbox"/> Change sensor placement. Recommended 6-10 diameters from elbows, and 30 diameters from pumps, controlling valves, orifice plates, nozzles or open pipe discharge

## **COMMON QUESTIONS AND ANSWERS**

*The pipe vibrates. Will it affect the flow meter?*

Common vibration frequencies are far lower than the sonic frequencies used by the Greyline flow meter, and will not normally affect accuracy or performance. However, applications where very weak Doppler signal is present (when sensitivity is adjusted to maximum and signal strength is low), accuracy may be affected by pipe vibration, or the flow meter may show readings under no-flow conditions. Attempt to relocate the sensor on a pipe section where vibration is reduced, or arrange pipe mounting brackets to reduce vibration at the sensor mounting location.

*The flow meter must be installed in a high noise environment. Will this affect operation?*

Greyline flow meters are designed to discriminate between environmental noise and the Doppler signal. High noise environments may affect the flow meter's performance where low signal strength and/or low flow velocities are being measured. If adjustment of the flow meter sensitivity does not eliminate noise interference a non-acoustic flow meter should be considered for the application.

*Will pipe corrosion affect accuracy of the flow meter?*

Yes. Rust, loose paint etc. must be removed from the outside of the pipe to provide a clean mounting position when installing a Doppler sensor. Severe corrosion/oxidation on the inside of the pipe may prevent the Doppler signal from penetrating into the flow. If the pipe cannot be cleaned, a spool piece (PVC recommended) should be installed for sensor mounting.

*What effect do pipe liners have on the flow meter?*

The air gap between loose insertion liners and the pipe wall prevent the Doppler signal from entering the flow. Better results can be expected with bonded liners such as cement, epoxy or tar, however an on site test is recommended to determine if the application is suitable for a Doppler flow meter.

*Why is Doppler only recommended for liquids containing suspended solids or gases?*

The Doppler sensor transmits sound into the flow stream which must be reflected back to the sensor to indicate flow velocity. Gas bubbles or suspended solids act as reflectors for the Doppler signal. As a guideline, Greyline Doppler flow meters are recommended for liquids containing solids or bubbles with a minimum size of 100 microns and a minimum concentration of 75 ppm. Most applications (except distilled or deionized water) will meet this minimum requirement.

*Can the sensor be submerged in water?*

Yes, for short periods of time or by accident, but not for continuous operation. The sensor is constructed to withstand submersion to 10 psi without damage, but external liquid moving in contact with the sensor can be interpreted as flow and cause false readings.

*What is the purpose of the Signal Strength Display and Sensitivity adjustment?*

Doppler signals of low strength (left of the ✕ on the signal strength display) are not accepted or processed by the instrument. This feature assists in rejection of environmental noise and vibration. For optimum noise rejection the sensitivity control should be adjusted so that signal strength is to the right of the ✕ on the signal strength display with flow and to the left of the ✕ with no flow.

*Can I change the length of the sensor cable?*

Yes. A 50 ft. (15 m) sensor cable extension with connectors is available from Greyline Instruments (Option PXC).

*Does the direction of flow matter for Sensor mounting?*

The PDFM-IV Doppler flow meter will measure and totalize flow in either direction. A check valve should be used in applications where backflow may occur.

*Does the PDFM-IV require periodic recalibration?*

No. PDFM-IV calibration does not drift over time. The solid state sensor has no moving parts to wear and affect calibration. The Doppler flow technique generates an ultrasonic signal proportional to the velocity of flow. All Greyline timing/counting circuits use crystal-controlled frequency references to eliminate any drift in the processing circuitry.

## LIMITED WARRANTY

Greyline Instruments warrants, to the original purchaser, its products to be free from defects in material and workmanship for a period of one year from date of invoice. Greyline will replace or repair, free of charge, any Greyline product if it has been proven to be defective within the warranty period. This warranty does not cover any expenses incurred in the removal and re-installation of the product.

If a product manufactured by Greyline should prove defective within the first year, return it freight prepaid to Greyline Instruments along with a copy of your invoice.

This warranty does not cover damages due to improper installation or handling, acts of nature, or unauthorized service. Modifications to or tampering with any part shall void this warranty. This warranty does not cover any equipment used in connection with the product or consequential damages due to a defect in the product.

All implied warranties are limited to the duration of this warranty. This is the complete warranty by Greyline and no other warranty is valid against Greyline. Some states do not allow limitations on how long an implied warranty lasts or limitation of incidental or consequential damages, so the above limitations or exclusions may not apply to you.

This warranty gives you specific legal rights, and you may also have other rights which vary from state to state.

Greyline Instruments Inc.

## **APPLICATIONS HOTLINE**

For applications assistance, advice or information on any Greyline Instrument contact your Sales Representative, write to Greyline or phone the Applications Hotline below:

<b>United States:</b>	<b>Tel: 315-788-9500</b>	<b>Fax: 315-764-0419</b>
<b>Canada:</b>	<b>Tel: 613-938-8956</b>	<b>Fax: 613-938-4857</b>
<b>Toll Free:</b>	<b>888-473-9546</b>	
<b>Email:</b>	<b>info@greyline.com</b>	
<b>Web Site:</b>	<b>www.greyline.com</b>	

Greyline Instruments Inc.

Canada  
16456 Sixsmith Drive  
Long Sault, Ont. K0C 1P0

USA:  
407 County Route 46  
Massena, NY 13662

## **PRODUCT RETURN PROCEDURE**

Instruments may be returned to Greyline for service or warranty repair. Before shipping a product to the factory please contact Greyline by telephone or Fax to obtain an RMA number (Returned Merchandise Authorization). This ensures fast service and correct billing or credit.

When you contact Greyline please have the following information available:

1. Model number / Software Version
2. Serial number
3. Date of Purchase
4. Reason for return (description of fault or modification required)
5. Your name, company name, address and phone number

After obtaining an RMA number please ship the product to the appropriate address below:

*Canadian and International  
Customers:*

Greyline Instruments Inc.  
16456 Sixsmith Drive  
Long Sault, Ont. K0C 1P0

RMA#

*USA  
Customers:*

Greyline Instruments Inc.  
407 County Route 46  
Massena, NY 13662

RMA#

**APPENDIX A - OPTIONS**

**PSE5H – High Temperature Doppler Sensor**

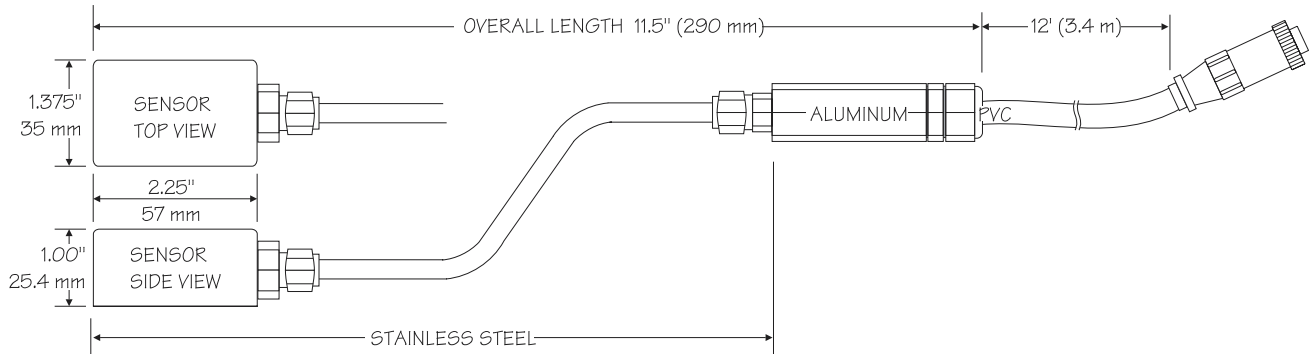

- Minimum Pipe Diameter:** 0.5" (12.5 mm) ID, 0.6" (15 mm) OD
- Maximum Pipe diameter:** 180" (4.5 m) ID
- Operating Temperature:** -40° to 302°F (-40° to 150°C)
- Operating Frequency:** 640KHz
- Sensor Housing:** Stainless Steel with Epoxy face
- Sensor Cable:** 12 ft. (3.4 m) RG174U shielded coaxial pair
- Note:** Protect sensor cable from contact with hot pipes.

**APPENDIX B – CONVERSION TABLES**

CONVERSION GUIDE		
FROM	TO	MULTIPLY BY
US GALLONS	CUBIC FEET	0.1337
US GALLONS	IMPERIAL GALS	0.8327
US GALLONS	LITRES	3.785
US GALLONS	CUBIC METERS	0.003785
LITRES/SEC	GPM	15.85
LITRES	CUBIC METERS	0.001
BARRELS	US GALLONS	42
BARRELS	IMPERIAL GALS	34.9726
BARRELS	LITRES	158.9886
INCHES	MM	25.4
DEGREES F	DEGREES C	$(^{\circ}\text{F}-32) \times 0.556$
POUNDS	KILOGRAMS	0.453
PSI	BAR	0.0676
FOOT <sup>2</sup>	METER <sup>2</sup>	0.0929

**SPECIFICATIONS:**

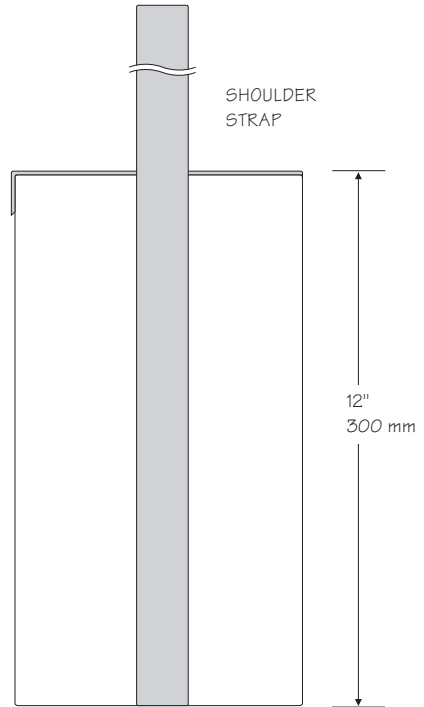
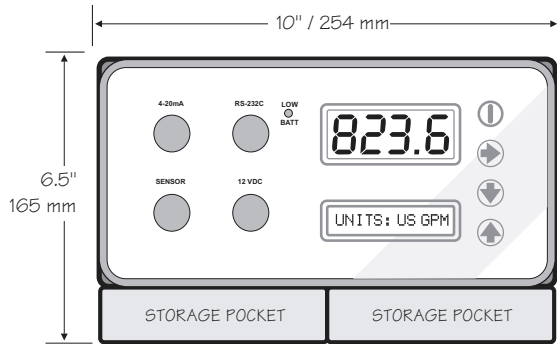

SIDE VIEW

1. Dimensions are approximate. Case is made from padded Cordura with storage pockets for the Sensor, Cables and Sensor Mounting Kit.
2. Approximate total weight is 9lbs (4kg)
3. Operating temperature is -10° to 140°F (-23° to 60°C)
4. Operates for approximately 16 hours from a built-in, rechargeable battery. For continuous operation provide 115VAC (230VAC optional), or 12VDC power input.

**PSE5 - DOPPLER SENSOR (standard)**

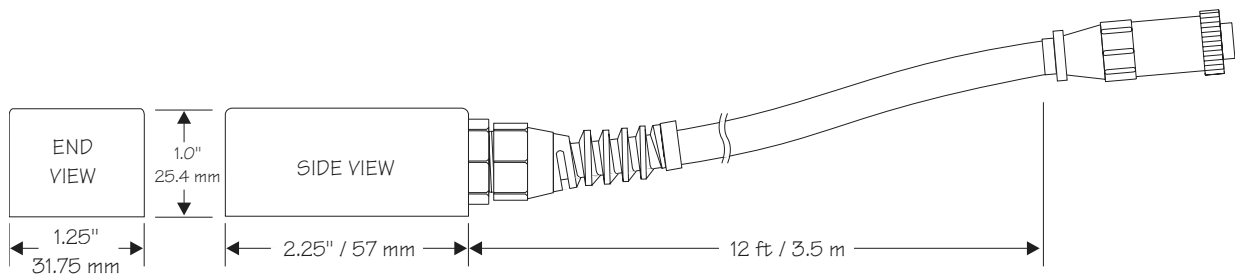

- Minimum Pipe Diameter:** 0.5" (12.5 mm) ID, 0.6" (15 mm) OD
- Maximum Pipe diameter:** 180" (4.5 m) ID
- Operating Temperature:** -40° to 200°F (-40° to 93°C)
- Operating Frequency:** 640KHz
- Sensor Housing:** Stainless Steel with Epoxy face
- Sensor Cable:** 12 ft (3.5 m) shielded coaxial pair with connecting plug.

**PIPE CHARTS**

**Carbon Steel & PVC Pipe**

Pipe Size	Pipe O.D.	Standard		Extra Heavy		Dbl. Extra Heavy		Schedule 10		Schedule 20		Schedule 30		Schedule 40	
		I.D.	WALL	I.D.	WALL	I.D.	WALL	I.D.	WALL	I.D.	WALL	I.D.	WALL	I.D.	WALL
½	.840	.622	.109	.546	.147	.252	.294							.622	.109
¼	1.050	.824	.113	.742	.154	.434	.308							.824	.113
1	1.315	1.049	.133	.957	.179	.599	.358							1.049	.133
1¼	1.660	1.380	.140	1.278	.191	.896	.382							1.380	.140
1½	1.900	1.610	.145	1.500	.200	1.100	.400							1.610	.145
2	2.375	2.067	.154	1.939	.218	1.503	.436							2.067	.154
2½	2.875	2.469	.203	2.323	.276	1.771	.552							2.469	.203
3	3.500	3.068	.216	2.900	.300	2.300	.600							3.068	.216
3½	4.000	3.548	.226	3.364	.318	2.728	.636							3.548	.226
4	4.500	4.026	.237	3.826	.337	3.152	.674							4.026	.237
5	5.563	5.047	.258	4.813	.375	4.063	.750							5.047	.258
6	6.625	6.065	.280	5.761	.432	4.897	.864							6.065	.280
8	8.625	7.981	.322	7.625	.500	6.875	.875			8.125	.250	8.071	.277	7.981	.322
10	10.750	10.020	.365	9.750	.500	8.750	1.000			10.250	.250	10.136	.307	10.020	.365
12	12.750	12.000	.375	11.750	.500	10.750	1.000			12.250	.250	12.090	.330	11.938	.406
14	14.000	13.250	.375	13.000	.500			13.500	.250	13.376	.312	13.250	.375	13.124	.438
16	16.000	15.250	.375	15.000	.500			15.500	.250	15.376	.312	15.250	.375	15.000	.500
18	18.000	17.250	.375	17.000	.500			17.500	.250	17.376	.312	17.124	.438	16.876	.562
20	20.000	19.250	.375	19.000	.500			19.500	.250	19.250	.375	19.000	.500	18.814	.593
22	22.000	21.250	.375	21.000	.500			21.500	.250	21.250	.375	21.000	.500		
24	24.000	23.250	.375	23.000	.500			23.500	.250	23.250	.375	22.876	.562	22.626	.687
26	26.000	25.250	.375	25.000	.500			25.376	.312	25.000	.500				
28	28.000	27.250	.375	27.000	.500			27.376	.312	27.000	.500	26.750	.625		
30	30.000	29.250	.375	29.000	.500			29.376	.312	29.000	.500	28.750	.625		
32	32.000	31.250	.375	31.000	.500			31.376	.312	31.000	.500	30.750	.625		
34	34.000	33.250	.375	33.000	.500			33.376	.312	33.000	.500	32.750	.625		
36	36.000	35.250	.375	35.000	.500			35.376	.312	35.000	.500	34.750	.625		
42	42.000	41.250	.375	41.000	.500					41.000	.500	40.750	.625		

**Ductile Iron Pipe - Standard Classes**

Size INCH	OUTSIDE DIA. INCH	Class 50		Class 51		Class 52		Class 53		Class 54		Class 55		Class 56		CEMENT LINING	
		WALL	I.D.	WALL	I.D.	WALL	I.D.	WALL	I.D.	WALL	I.D.	WALL	I.D.	WALL	I.D.	**STD THICKNESS	**DOUBLE THICKNESS
3	3.96			0.25	3.46	0.28	3.40	0.31	3.34	0.34	3.28	0.37	3.22	0.41	3.14		
4	4.80			0.26	4.28	0.29	4.22	0.32	4.16	0.35	4.10	0.38	4.04	0.44	3.93		
6	6.90	0.25	6.40	0.28	6.34	0.31	6.28	0.34	6.22	0.37	6.16	0.40	6.10	0.43	6.04	.125	.250
8	9.05	0.27	8.51	0.30	8.45	0.33	8.39	0.36	8.33	0.39	8.27	0.42	8.21	0.45	8.15		
10	11.10	0.39	10.32	0.32	10.46	0.35	10.40	0.38	10.34	0.41	10.28	0.44	10.22	0.47	10.16		
12	13.20	0.31	12.58	0.34	12.52	0.37	12.46	0.40	12.40	0.43	12.34	0.46	12.28	0.49	12.22		
14	15.30	0.33	14.64	0.36	14.58	0.39	14.52	0.42	14.46	0.45	14.40	0.48	14.34	0.51	14.28		
16	17.40	0.34	16.72	0.37	16.66	0.40	16.60	0.43	16.54	0.46	16.48	0.49	16.42	0.52	16.36		
18	19.50	0.35	18.80	0.38	18.74	0.41	18.68	0.44	18.62	0.47	18.56	0.50	18.50	0.53	18.44	.1875	.375
20	21.60	0.36	20.88	0.39	20.82	0.42	20.76	0.45	20.70	0.48	20.64	0.51	20.58	0.54	20.52		
24	25.80	0.38	25.04	0.41	24.98	0.44	24.92	0.47	24.86	0.50	24.80	0.53	24.74	0.56	24.68		
30	32.00	0.39	31.22	0.43	31.14	0.47	31.06	0.51	30.98	0.55	30.90	0.59	30.82	0.63	30.74		
36	38.30	0.43	37.44	0.48	37.34	0.62	37.06	0.58	37.14	0.63	37.04	0.68	36.94	0.73	36.84		
42	44.50	0.47	43.56	0.53	43.44	0.59	43.32	0.65	43.20	0.71	43.08	0.77	42.96	0.83	42.84	.250	.500
48	50.80	0.51	49.78	0.58	49.64	0.65	49.50	0.72	49.36	0.79	49.22	0.86	49.08	0.93	48.94		
54	57.10	0.57	55.96	0.65	55.80	0.73	55.64	0.81	55.48	0.89	55.32	0.97	55.16	1.05	55.00		

\*\*REDUCE I.D. BY DIMENSION SHOWN

**Stainless Steel, Hastelloy "C" & Titanium Pipe**

Pipe Size	Pipe O.D.	Schedule 5 S (a)		Schedule 10 S (a)		Schedule 40 S		Schedule 80 S	
		I.D.	WALL	I.D.	WALL	I.D.	WALL	I.D.	WALL
½	.840	.710	.065	.674	.083	.622	.109	.546	.147
¼	1.050	.920	.065	.884	.083	.824	.113	.742	.154
1	1.315	1.185	.065	1.097	.109	1.049	.133	.957	.179
1¼	1.660	1.530	.065	1.442	.109	1.380	.140	1.278	.191
1½	1.900	1.770	.065	1.682	.109	1.610	.145	1.500	.200
2	2.375	2.245	.065	2.157	.109	2.067	.154	1.939	.218
2½	2.875	2.709	.083	2.635	.120	2.469	.203	2.323	.276
3	3.500	3.334	.083	3.260	.120	3.068	.216	2.900	.300
3½	4.000	3.834	.083	3.760	.120	3.548	.226	3.364	.318
4	4.500	4.334	.083	4.260	.120	4.026	.237	3.826	.337
5	5.563	5.345	.109	5.295	.134	5.047	.258	4.813	.375
6	6.625	6.407	.109	6.357	.134	6.065	.280	5.761	.432
8	8.625	8.407	.109	8.329	.148	7.981	.322	7.625	.500
10	10.750	10.482	.134	10.420	.165	10.020	.365	9.750	.500
12	12.750	12.438	.156	12.390	.180	12.000	.375	11.750	.500
14	14.000	13.688	.156	13.624	.188				
16	16.000	15.670	.165	15.624	.188				
18	18.000	17.670	.165	17.624	.188				
20	20.000	19.634	.188	19.564	.218				
22	22.000	21.624	.188	21.564	.218				
24	24.000	23.563	.218	23.500	.250				

Pipe Size	Pipe O.D.	Schedule 60		Schedule 80		Schedule 100		Schedule 120		Schedule 140		Schedule 160	
		I.D.	WALL	I.D.	WALL	I.D.	WALL	I.D.	WALL	I.D.	WALL	I.D.	WALL
½	.840			.546	.147							.466	.187
¼	1.050			.742	.154							.614	.218
1	1.315			.957	.179							.815	.250
1¼	1.660			1.278	.191							1.160	.250
1½	1.900			1.500	.200							1.338	.281
2	2.375			1.939	.218							1.689	.343
2½	2.875			2.323	.276							2.125	.375
3	3.500			2.900	.300							2.624	.438
3½	4.000			3.364	.318								
4	4.500			3.826	.337			3.624	.438			3.438	.531
5	5.563			4.813	.375			4.563	.500			4.313	.625
6	6.625			5.761	.432			5.501	.562			5.189	.718
8	8.625	7.813	.406	7.625	.500	7.439	.593	7.189	.718	7.001	.812	6.813	.906
10	10.750	9.750	.500	9.564	.593	9.314	.718	9.064	.843	8.750	1.000	8.500	1.125
12	12.750	11.626	.562	11.376	.687	11.064	.843	10.750	1.000	10.500	1.125	10.126	1.312
14	14.000	12.814	.593	12.500	.750	12.126	.937	11.814	1.093	11.500	1.250	11.188	1.406
16	16.000	14.688	.656	14.314	.843	13.938	1.031	13.564	1.218	13.124	1.438	12.814	1.593
18	18.000	16.500	.750	16.126	.937	15.688	1.156	15.250	1.375	14.876	1.562	14.438	1.781
20	20.000	18.376	.812	17.938	1.031	17.438	1.281	17.000	1.500	16.500	1.750	16.064	1.968
22	22.000	20.250	.875	19.750	1.125	19.250	1.375	18.750	1.625	18.250	1.875	17.750	2.125
24	24.000	22.064	.968	21.564	1.218	20.938	1.531	20.376	1.812	19.876	2.062	19.314	2.343

**Cast Iron Pipe - ASA Standard**

Pipe Size	Pipe O.D.	Class 50		Class 100		Class 150		Class 200		Class 250		Class 300		Class 350	
		WALL	I.D.	WALL	I.D.	WALL	I.D.	WALL	I.D.	WALL	I.D.	WALL	I.D.	WALL	I.D.
3	3.96	0.32	3.32	0.32	3.32	0.32	3.32	0.32	3.32	0.32	3.32	0.32	3.32	0.32	3.32
4	4.80	0.35	4.10	0.35	4.10	0.35	4.10	0.35	4.10	0.35	4.10	0.35	4.10	0.35	4.10
6	6.90	0.38	6.14	0.38	6.14	0.38	6.14	0.38	6.14	0.38	6.14	0.38	6.14	0.38	6.14
8	9.05	0.41	8.23	0.41	8.23	0.41	8.23	0.41	8.23	0.41	8.23	0.41	8.23	0.41	8.23
10	11.10	0.44	10.22	0.44	10.22	0.44	10.22	0.44	10.22	0.44	10.22	0.48	10.14	0.52	10.06
12	13.20	0.48	12.24	0.48	12.24	0.48	12.24	0.48	12.24	0.52	12.16	0.52	12.16	0.56	12.08
14	15.30	0.48	14.34	0.51	14.28	0.51	14.28	0.55	14.20	0.59	14.12	0.59	14.12	0.64	14.02
16	17.40	0.54	16.32	0.54	16.32	0.54	16.32	0.58	16.24	0.63	16.14	0.68	16.04	0.68	16.04
18	19.50	0.54	18.42	0.58	18.34	0.58	18.34	0.63	18.24	0.68	18.14	0.73	18.04	0.79	17.92
20	21.60	0.57	20.46	0.62	20.36	0.62	20.36	0.67	20.26	0.72	20.16	0.78	20.04	0.84	19.92
24	25.80	0.63	24.54	0.68	24.44	0.73	24.34	0.79	24.22	0.79	24.22	0.85	24.10	0.92	23.96

**Cast Iron Pipe - AWWA Standard**

Pipe Size	Class A 100 Ft. 43 PSIG			Class B 200 Ft. 86 PSIG			Class C 300 Ft. 130 PSIG			Class D 400 Ft. 173 PSIG		
	O.D.	WALL	I.D.	O.D.	WALL	I.D.	O.D.	WALL	I.D.	O.D.	WALL	I.D.
3	3.80	0.39	3.02	3.96	0.42	3.12	3.96	0.45	3.06	3.96	0.48	3.00
4	4.80	0.42	3.96	5.00	0.45	4.10	5.00	0.48	4.04	5.00	0.52	3.96
6	6.90	0.44	6.02	7.10	0.48	6.14	7.10	0.51	6.08	7.10	0.55	6.00
8	9.05	0.46	8.13	9.05	0.51	8.03	9.30	0.56	8.18	9.30	0.60	8.10
10	11.10	0.50	10.10	11.10	0.57	9.96	11.40	0.62	10.16	11.40	0.68	10.04
12	13.20	0.54	12.12	13.20	0.62	11.96	13.50	0.68	12.14	13.50	0.75	12.00
14	15.30	0.57	14.16	15.30	0.66	13.98	15.65	0.74	14.17	15.65	0.82	14.01
16	17.40	0.60	16.20	17.40	0.70	16.00	17.80	0.80	16.20	17.80	0.89	16.02
18	19.50	0.64	18.22	19.50	0.75	18.00	19.92	0.87	18.18	19.92	0.96	18.00
20	21.60	0.67	20.26	21.60	0.80	20.00	22.06	0.92	20.22	22.06	1.03	20.00
24	25.80	0.76	24.28	25.80	0.89	24.02	26.32	1.04	24.22	26.32	1.16	24.00
30	31.74	0.88	29.98	32.00	1.03	29.94	32.40	1.20	30.00	32.74	1.37	30.00
36	37.96	0.99	35.98	38.30	1.15	36.00	38.70	1.36	39.98	39.16	1.58	36.00
42	44.20	1.10	42.00	44.50	1.28	41.94	45.10	1.54	42.02	45.58	1.78	42.02
48	50.50	1.26	47.98	50.80	1.42	47.96	51.40	1.71	47.98	51.98	1.96	48.06
54	56.66	1.35	53.96	57.10	1.55	54.00	57.80	1.90	54.00	58.40	2.23	53.94
60	62.80	1.39	60.02	63.40	1.67	60.06	64.20	2.00	60.20	64.82	2.38	60.06
72	75.34	1.62	72.10	76.00	1.95	72.10	76.88	2.39	72.10			
84	87.54	1.72	84.10	88.54	2.22	84.10						

Pipe Size	Class E 500 Ft. 217 PSIG			Class F 600 Ft. 260 PSIG			Class G 700 Ft. 304 PSIG			Class H 800 Ft. 347 PSIG		
	O.D.	WALL	I.D.	O.D.	WALL	I.D.	O.D.	WALL	I.D.	O.D.	WALL	I.D.
6	7.22	0.58	6.06	7.22	0.61	6.00	7.38	0.65	6.08	7.38	0.69	6.00
8	9.42	0.66	8.10	9.42	0.71	8.00	9.60	0.75	8.10	9.60	0.80	8.00
10	11.60	0.74	10.12	11.60	0.80	10.00	11.84	0.86	10.12	11.84	0.92	10.00
12	13.78	0.82	12.14	13.78	0.89	12.00	14.08	0.97	12.14	14.08	1.04	12.00
14	15.98	0.90	14.18	15.98	0.99	14.00	16.32	1.07	14.18	16.32	1.16	14.00
16	18.16	0.98	16.20	18.16	1.08	16.00	18.54	1.18	16.18	18.54	1.27	16.00
18	20.34	1.07	18.20	20.34	1.17	18.00	20.78	1.28	18.22	20.78	1.39	18.00
20	22.54	1.15	20.24	22.54	1.27	20.00	23.02	1.39	20.24	23.02	1.51	20.00
24	26.90	1.31	24.28	26.90	1.45	24.00	27.76	1.75	24.26	27.76	1.88	24.00
30	33.10	1.55	30.00	33.46	1.73	30.00						
36	39.60	1.80	36.00	40.04	2.02	36.00						