

HI 98194, HI 98195, HI 98196

Multiparameter Meters



Dear Customer,

Thank you for choosing a HANNA Instruments® product.

Please read this instruction manual carefully before using the instrument.

It will provide you with the necessary information for correct use of the instrument, as well as its versatility.

If you need additional technical information, do not hesitate to e-mail us at **tech@hannainst.com** or visit our website www.hannainst.com for our worldwide contact list.

TABLE OF CONTENTS

CHAPTER 1- INTRODUCTION	6
1.1 Preliminary Examination	6
1.2 Model Identification	6
1.3 General Description	6
1.4 Display and Keypad Description	8
CHAPTER 2 - QUICK START	9
2.1 Sensor and Probe Installation	9
2.2 Basic Operation	11
2.3 Help Function	11
CHAPTER 3 - SPECIFICATIONS	12
3.1 System Specifications	12
3.2 Probe Specifications	16
3.3 Sensor Specifications	17
CHAPTER 4 - PROBE INSTALLATION	18
4.1 Sensor Descriptions	18
4.2 Sensor Preparation/Activation	19
4.2.1 pH Preparation	19
4.2.2 ORP Activation	19
4.2.3 D.O. Sensor Activation	20
4.2.4 EC Sensor Preparation	20
4.3 Sensor Installation	20
CHAPTER 5 - INITIALIZATION AND MEASUREMENT	23
5.1 Battery Installation	23
5.2 Meter Initialization	24
5.3 Measurement Mode	25
5.4 Setup Menu Structure	26
CHAPTER 6 - PARAMETER SETUP MENU	27
6.1 Select Parameters	27
6.2 Parameter Units	27
6.2.1 Temperature Unit	27
6.2.2 TDS Unit (HI 98194, HI 98195 only)	27
6.2.3 DO Concentration Unit (HI 98194, HI 98196 only)	27
6.2.4 Pressure Unit	27

HANNA instruments® reserves the right to modify the design, construction or appearance of its products without advance notice.
--

6.2.5 Resistivity Unit (HI 98194, HI 98195 only)	28
6.2.6 Seawater Sigma Unit (HI 98194, HI 98195 only)	28
6.2.7 EC Resolution Unit (HI 98194, HI 98195 only)	28
6.2.8 Absolute EC Resolution Unit (HI 98194, HI 98195 only)	28
6.2.9 TDS Resolution Unit (HI 98194, HI 98195 only)	28
6.3 Parameter Coefficients	29
6.3.1 EC Reference Temperature (HI 98194, HI 98195 only)	29
6.3.2 EC Temperature Coefficient (HI 98194, HI 98195 only)	29
6.3.3 TDS Factor (HI 98194, HI 98195 only)	29
6.4 Averaging	29
CHAPTER 7 - CALIBRATION MODE	30
7.1 Quick Calibration	31
7.2 pH Calibration	32
7.2.1 Preparation	32
7.2.2 Procedure	33
7.2.3 pH Calibration Error Messages	34
7.3 Relative mV Calibration	35
7.3.1 Preparation	36
7.3.2 Procedure	36
7.4 Dissolved Oxygen Calibration (HI 98194, HI 98196 only)	36
7.5 Conductivity Calibration (HI 98194, HI 98195 only)	38
7.6 Temperature Calibration	42
7.7 Atmospheric Pressure Calibration	43
CHAPTER 8 - SYSTEM SETUP	44
8.1 Meter Setup	44
8.1.1 Time	44
8.1.2 Date	44
8.1.3 Auto Poweroff	45
8.1.4 Key Beep	45
8.1.5 Error Beep	45
8.1.6 Decimal Separator	45
8.1.7 LCD Contrast	45
8.1.8 LCD Backlight Intensity	46

8.1.9 Meter Password	46
8.1.10 Meter ID	46
8.1.11 Language	47
8.1.12 Restore Factory Settings	47
8.2 Probe Setup	47
8.2.1 Probe ID	47
CHAPTER 9 - STATUS	48
9.1 Meter Status	48
9.2 Probe Status	48
9.3 GLP Data	49
CHAPTER 10 - LOGGING MODE	52
10.1 Logging Menu Structure	53
10.2 Logging On Meter	53
10.2.1 One Sample On Meter	54
10.2.2 Continuous Meter Log	54
10.3 Log Recall	55
10.4 Log Notes	56
10.4.1 Remarks	56
10.4.2 Delete All Remarks	56
CHAPTER 11 - PC CONNECTION	57
11.1 Software Installation	57
11.2 Meter to PC Connection	57
CHAPTER 12 - TROUBLESHOOTING / ERROR MESSAGES	59
APPENDIX	
A - PROBE MAINTENANCE	61
B - PROBE DEPLOYMENT	63
C - ACCESSORIES	65
D - WARRANTY	70

Chapter 1 - INTRODUCTION

1.1 PRELIMINARY EXAMINATION

Remove the instrument from the packing material and examine it carefully to make sure that no damage has occurred during shipping. If there is any damage, notify your Dealer or the nearest HANNA Customer Service Center immediately.

Note Save all packing materials until you are sure that the instrument functions correctly. Any damaged or defective items must be returned in their original packing material with the supplied accessories.

1.2 MODEL IDENTIFICATION

HI 98194 pH/EC/DO Multiparameter meter with **HI 7698194** probe.

HI 98195 pH/ORP/TDS/NaCl/Resistivity meter with **HI 7698195** probe.

HI 98196 pH/ORP/Dissolved Oxygen meter with **HI 7698196** probe.

1.3 GENERAL DESCRIPTION

HI 9819X is a portable logging multiparameter system (instrument, probe) that monitors up to 14 different water quality parameters (7 measured, 7 calculated). The microprocessor-based intelligent multisensor probes allows measurement of many water quality parameters such as pH, ORP, dissolved oxygen, conductivity and temperature with data logging. The system is easy to setup and easy to use. The **HI 9819X** features a graphic, backlit display that automatically sizes the digits to fit the screen with on-screen graphing capability. Each parameter is fully configurable.

HI 9819X was designed to withstand harsh environments and is the ideal solution for field measurements of lakes, rivers and sea.

The meter meets IP67 standards (30 minute immersion at a depth of 1 m) and the multisensor probe meets IP68 standards (continuous immersion in water).

Main features of the **HI 9819X** systems:

- Rugged meter and probe
- Easy to use
- Measure up to 14 parameters and display of up to 12 parameters
- Waterproof protection (IP67 for the meter and IP68 for the probe)
- Graphic LCD with backlight
- Built-in barometer for D.O. concentration compensation (**HI 98194, HI 98196** only)
- Quick calibration feature
- Measurement check to eliminate any erroneous readings
- Autorecognition of probe and sensors
- Log-on-demand and automatic logging (up to 45,000 samples) on meter for all parameters
- Graphical display of logged data
- USB interface for PC communication
- Auto-ranging for EC readings (**HI 98194, HI 98195** only)
- Good Laboratory Practice feature, the last 5 calibrations are automatically stored
- Field-replaceable sensors with color coded caps
- Meter is powered with alkaline batteries

1.4 DISPLAY AND KEYBOARD DESCRIPTION

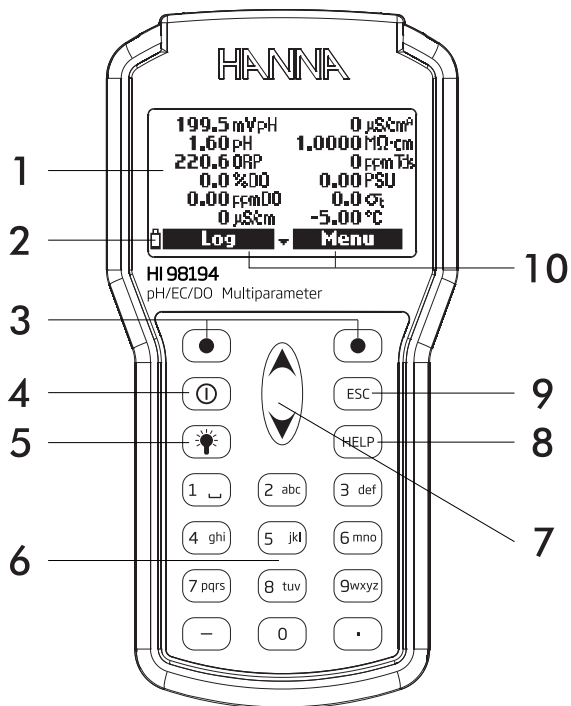

1. Graphic LCD
2. Battery level indicator
3. Softkeys
4. On/Off key: turn the meter on and off
5. Lamp key: turn the backlight on and off
6. Alphanumeric keyboard: insert alphanumeric codes
7. Arrow keys: scroll the displayed options/message
8. HELP key: obtain information about the displayed screen
9. ESC key: return to the previous screen
10. Softkey functions defined on display

Chapter 2 - QUICK START

2.1 SENSOR AND PROBE INSTALLATION

- Sensor o-rings must be lubricated with the supplied grease prior to installation.
- HI 769819X probes have 2 or 3 sensor connectors sockets identified with color-coded triangles:
- Connector 1 (red): For either pH/ORP, pH sensor
- Connector 2 (white): For dissolved oxygen sensor (HI 98194, HI 98196 only)
- Connector 3 (blue): For EC sensor (HI 98194, HI 98195 only)
- Position the connector key towards the center of the probe, make sure the connector is seated correctly (the sensor will no longer move freely) before tightening the locking threads.
- To protect the sensors, screw the protective shield onto the probe body.
- With the meter off, connect the probe to the instrument input on the top of the meter. Align the pins and key then push the plug into the socket and tighten the thread.
- Turn the meter on by pressing the On/Off key. The meter will automatically recognize the probe and the installed sensors and identify them on the probe status screen.
- Press **Measure** to view the measurement screen.



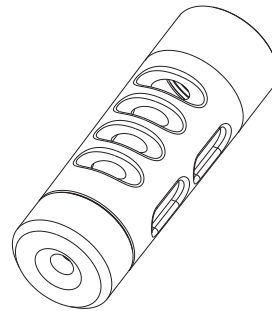
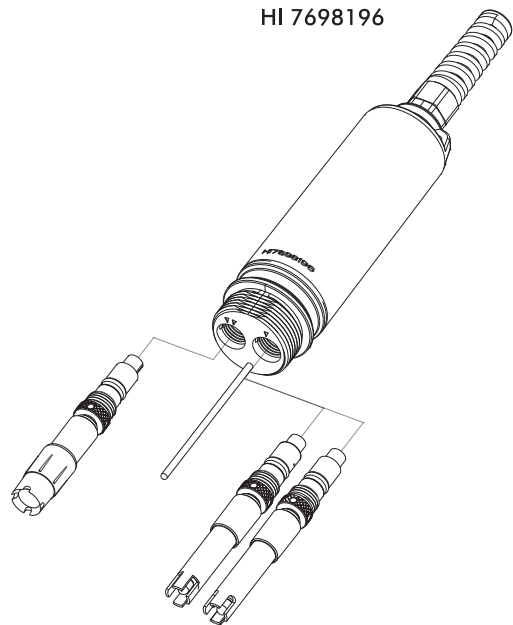
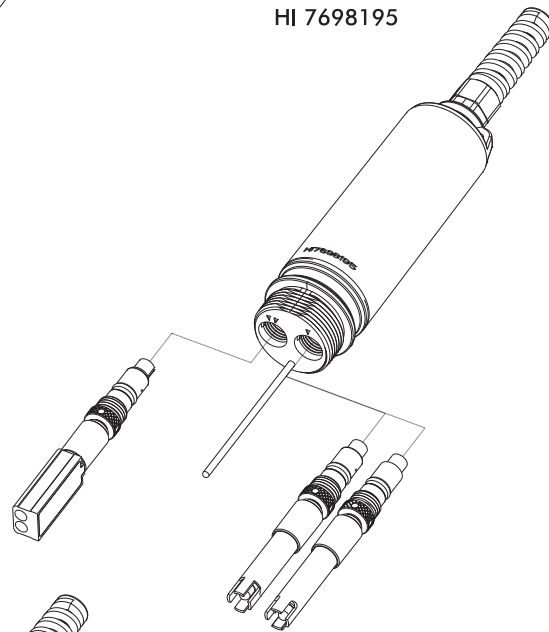
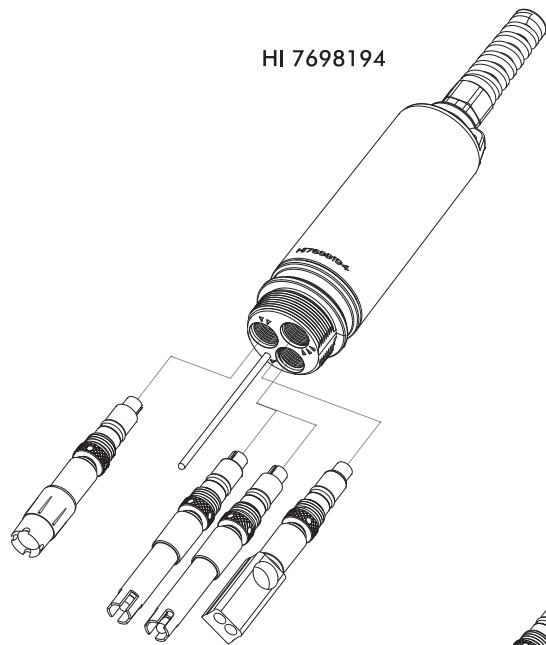

2.2 BASIC OPERATION

The main operating modes for **HI 9819X** are measurement, logging and setup. The measurement screen can be configured to display a single measurement or up to 12 simultaneous measurements by using the numbers 1-7 on the keypad. Use the arrow keys to scroll through the measurements not being displayed. See section 5.3 for more details.

The measurement units will blink if the system has not been calibrated and the measurement number will blink when the reading is out of range.

Press **Log** to display the logging menu. You can either log a single sample on the meter or start an interval log on the meter. See chapter 10 for more details.

Press **Menu** to enter setup mode. You can configure which parameters you want to measure, calibrate the sensors, change system settings and view the meter and probe status.

2.3 HELP FUNCTION

HI 9819X features context sensitive **HELP**, which provides useful information regarding the displayed screen.

Simply press the **HELP** key to access this function, then use the arrow keys to scroll through the message.

To escape from the **HELP** window, press the **HELP** key again or **ESC**.

Chapter 3 - SPECIFICATIONS

3.1 SYSTEM SPECIFICATIONS

TEMPERATURE

Range	-5.00 to 55.00 °C; 23.00 to 131.00 °F; 268.15 to 328.15 K
Resolution	0.01 °C; 0.01 °F; 0.01 K
Accuracy	± 0.15 °C; ± 0.27 °F; ±0.15 K
Calibration	Automatic at 1 custom point

pH/mV

Range	0.00 to 14.00 pH; ± 600.0 mV
Resolution	0.01 pH; 0.1 mV
Accuracy	± 0.02 pH; ± 0.5 mV
Calibration	Automatic 1, 2 or 3 points with automatic recognition of 5 standard buffers (pH 4.01, 6.86, 7.01, 9.18, 10.01) and 1 custom buffer

ORP

Range	± 2000.0 mV
Resolution	0.1 mV
Accuracy	± 1.0 mV
Calibration	Automatic at 1 custom point (relative mV)

DISSOLVED OXYGEN (HI 98194, HI 98196 only)

Range	0.0 to 500.0 % 0.00 to 50.00 ppm (mg/L)
Resolution	0.1 % 0.01 ppm (mg/L)
Accuracy	0.0 to 300.0 %: ± 1.5 % of reading or ± 1.0 % whichever is greater; 300.0 to 500.0 %: ± 3 % of reading 0.00 to 30.00 ppm (mg/L): ± 1.5 % of reading or ±0.10 ppm (mg/L) whichever is greater; 30.00 ppm (mg/L) to 50.00 ppm (mg/L): ± 3 % of reading
Calibration	Automatic 1 or 2 points at 0, 100 % or 1 custom point

CONDUCTIVITY (HI 98194, HI 98195 only)

Range	0 to 200 mS/cm (absolute EC up to 400 mS/cm)
Resolution	Manual 1 μS/cm; 0.001 mS/cm; 0.01 mS/cm; 0.1 mS/cm; 1 mS/cm Automatic 1 μS/cm from 0 to 9999 μS/cm 0.01 mS/cm from 10.00 to 99.99 mS/cm 0.1 mS/cm from 100.0 to 400.0 mS/cm
Automatic (mS/cm)	0.001 mS/cm from 0.000 to 9.999 mS/cm 0.01 mS/cm from 10.00 to 99.99 mS/cm 0.1 mS/cm from 100.0 to 400.0 mS/cm
Accuracy	±1 % of reading or ±1 μS/cm whichever is greater
Calibration	Automatic single point, with 6 standard solutions (84 μS/cm, 1413 μS/cm, 5.00 mS/cm, 12.88 mS/cm, 80.0 mS/cm, 111.8 mS/cm) or custom point

RESISTIVITY (HI 98194, HI 98195 only)

Range	0 to 999999 Ω·cm; (depending on measurement setup) 0 to 1000.0 kΩ·cm; 0 to 1.0000 MΩ·cm
Resolution	Depending on resistivity reading
Calibration	Based on conductivity or salinity calibration

TDS (Total Dissolved Solids) (HI 98194, HI 98195 only)

Range	0 to 400000 ppm (mg/L); (the maximum value depends on the TDS factor)
Resolution	Manual 1 ppm (mg/L); 0.001 ppt (g/L); 0.01 ppt (g/L); 0.1 ppt (g/L); 1 ppt (g/L) Automatic 1 ppm (mg/L) from 0 to 9999 ppm (mg/L) 0.01 ppt (g/L) from 10.00 to 99.99 ppt (g/L) 0.1 ppt (g/L) from 100.0 to 400.0 ppt (g/L)
Automatic ppt (g/L)	0.001 ppt (g/L) from 0.000 to 9.999 ppt (g/L) 0.01 ppt (g/L) from 10.00 to 99.99 ppt (g/L) 0.1 ppt (g/L) from 100.0 to 400.0 ppt (g/L)
Accuracy	±1 % of reading or ±1 ppm (mg/L) whichever is greater
Calibration	Based on conductivity or salinity calibration

SALINITY (HI 98194, HI 98195 only)

Range	0.00 to 70.00 PSU
Resolution	0.01 PSU
Accuracy	±2% of reading or ±0.01 PSU whichever is greater
Calibration	Based on conductivity calibration

SEAWATER SIGMA (HI 98194, HI 98195 only)

Range	0.0 to 50.0 $\sigma_t, \sigma_0, \sigma_{15}$
Resolution	0.1 $\sigma_t, \sigma_0, \sigma_{15}$
Accuracy	± 1 $\sigma_t, \sigma_0, \sigma_{15}$
Calibration	Based on conductivity or salinity calibration

ATMOSPHERIC PRESSURE

Range	450 to 850 mm Hg; 17.72 to 33.46 in Hg; 600.0 to 1133.2 mbar; 8.702 to 16.436 psi; 0.5921 to 1.1184 atm; 60.00 to 113.32 kPa
Resolution	0.1 mm Hg; 0.01 in Hg; 0.1 mbar 0.001 psi; 0.0001 atm; 0.01 kPa
Accuracy	±3 mm Hg within ±15°C from calibration temperature
Calibration	Automatic at 1 custom point

METER SPECIFICATIONS

Temperature Compensation	Automatic from -5 to 55 °C (23 to 131 °F)
Logging Memory	45,000 records (continuous logging or log-on-demand of all parameters)
Logging Interval	1 second to 3 hours
PC Interface	USB (with HI 9298194 software)
Waterproof Protection	IP67
Environment	0 to 50 °C (32 to 122 °F); RH 100 %
Battery Type	4 x 1.5 V, AA alkaline batteries
Battery Life	360 hours without backlight / 50 hours with backlight
Dimensions/Weight	221 x 115 x 55 mm (8.7 x 4.5 x 2.2") / 750 g (26.5 oz.)

METER BATTERY LIFE

The power consumption of the **HI 9819X** multiparameter systems are dependent on two things:

1. The measurement system configuration (sensor configuration)
2. The meter configuration (logging interval and backlight use)

The following table estimates the meter's battery life connected to a **HI 769819X** probe with backlight off. (**Note:** backlighting use consume the most power). The table variables, battery selection and parameter selection.

	pH/ ORP, DO, EC
Backlight OFF, 1 s log	280 hours
Backlight OFF, 4 min log	360 hours
Backlight OFF, 10 min log	400 hours
Backlight ON, 4 min log	50 minutes
Backlight ON, 10 min log	50 minutes

3.2 PROBE SPECIFICATIONS

Sensor Inputs	3 for HI 7698194 2 for HI 7698195 and HI 7698196
Sample Environment	Fresh, brackish, seawater
Waterproof protection	IP68
Operating Temperature	-5 to 55° C *
Storage Temperature	-20 to 70° C
Maximum Depth	20 m (66 ft.) *
Dimensions (without cable)	342mm (13.5"), dia=46 mm (1.8")
Weight (with batteries and sensors)	570g (20.1 oz.)
Cable Specification	Multistrand-multiconductor shielded cable with internal strength member rated for 68 kg (150 lb) intermittent use
Wetted Materials	Body: ABS Threads: Nylon Shield: ABS/ 316 SS Temp probe: 316 SS O-rings: EPDM

3.3 SENSOR SPECIFICATIONS

	HI 769828-0	HI 769828-1	HI 769828-2	HI 769828-3
Description	pH	pH/ORP	Dissolved Oxygen	EC
Measure Type				
Primary Unit	pH, mV (pH)	pH, mV (pH/ORP)	D.O. (% sat. & conc.)	EC
Measure Range	0.00 to 13.00 pH ±600.0 mV	0.00 to 13.00 pH ±600.0 mV ±2000.0 mV	0.0 to 500.0 % 0.00 to 50.00 mg/L	0.0 to 200.0 mS/cm 0.0 to 400 mS/cm (absolute)
Temperature Range	-5 to 55°C	-5 to 55°C	-5 to 55°C	-5 to 55°C
Color Code	Red	Red	White	Blue
Materials	Tip: glass (pH) Junction: ceramic Body: PEI Electrolyte: gel Reference: double	Tip: glass (pH); Pt (ORP) Junction: ceramic Body: PEI Electrolyte: gel Reference: double	Cat/An: Ag/Zn Membrane: HDPE Body: white top ABS CAP	Stainless steel electrodes AISI 316 Body: ABS/EPOXY
Maintenance Solution	HI 70300 (storage solution)	HI 70300 (storage solution)	HI 7042S (D.O. electrolyte)	none
Dimensions	118 x 15 mm	118 x 15 mm	99 x 17 mm	111 x 17 mm
Depth	20 m (65')	20 m (65')	20 m (65')	20 m (65')

Chapter 4 - PROBE INSTALLATION

4.1 SENSOR DESCRIPTIONS

HI 769828-0 Combination pH sensor features a glass pH sensitive bulb and a silver/silver chloride double junction reference with gelled electrolyte.

HI 769828-1 Combination pH/ORP sensor features a glass sensitive bulb for pH readings, a platinum sensor for redox measurements and a silver/silver chloride double junction reference with gelled electrolyte.

Note See section 4.2.1 for pH preparation.

See section 4.2.2 for ORP activation.

HI 769828-2 Galvanic dissolved oxygen (D.O.) sensor. The thin gas permeable membrane isolates the sensor elements from the testing solution but allows oxygen to pass through. The oxygen that passes through the membrane is reduced at the cathode and causes a current, from which the oxygen concentration is determined. The D.O. sensor conforms to Standard Methods 4500-AG, EPA 360.1.

Note The D.O. sensor needs to be activated before installation. See section 4.2.3 for details.

HI 769828-3 4 ring-electrode conductivity (EC/TDS/Resistivity/Salinity) sensor. The sensor is immune to polarization or surface coatings.

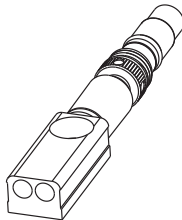
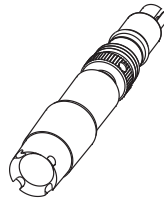
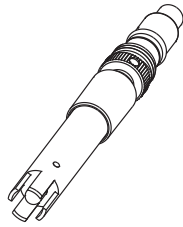

4.2 SENSOR PREPARATION / ACTIVATION

4.2.1 pH Preparation

Remove the shipping cap from the pH sensor. If the shipping cap does not contain any liquid, pour **HI 70300** into shipping cap, place it back on the sensor and soak for at least 1/2 hour before use. If **HI 70300** is not available, pH 4.01 buffer may be substituted.

4.2.2 ORP Activation

For improved redox measurements, the surface of the sensor must be clean and smooth. A pretreatment procedure should be performed to ensure quick response. The pretreatment of the sensor is determined by the pH and the ORP potential values of the sample. Use the table below to determine the treatment required. First locate the typical sample pH. If the corresponding ORP value (mV) is higher than the values in the table below, an oxidizing pretreatment is necessary. If the value is lower, a reducing pretreatment is necessary.

pH	mV	pH	mV	pH	mV	pH	mV	pH	mV
0	990	1	920	2	860	3	800	4	740
5	680	6	640	7	580	8	520	9	460
10	400	11	340	12	280	13	220	14	160

For reducing pretreatment: immerse the electrode for at least five minutes in **HI 7091**.

For oxidizing pretreatment: immerse the electrode for at least five minutes in **HI 7092**.

4.2.3 D.O. Sensor Activation

The D.O. probe is shipped dry. To prepare the sensor for use:

- Remove the black & red plastic cap. This cap is used for shipping purposes only and can be thrown away.
- Insert the supplied O-ring in to the membrane cap.
- Rinse the membrane with some electrolyte solution. Refill with clean electrolyte. Gently tap the membrane cap to dislodge air bubbles. To avoid damaging the membrane, do not touch it with your fingers or directly tap the membrane.
- With the sensor facing down screw the membrane cap counterclockwise to the end of the threads. Some electrolyte will overflow.
- Rinse outside of sensor with deionized water.
- Invert sensor and inspect. There should be no bubbles or debris between the membrane and sensor body.

4.2.4 EC Sensor Preparation

The EC sensor does not need to be soaked or hydrated before use. Use the small brush included in the probe maintenance kit to clean and loosen any debris before using.

4.3 SENSOR INSTALLATION

The **HI 7698194** can support three different sensors: Connector 1: pH, pH/ORP

Connector 2: D.O.

Connector 3: EC.

To make installation easier, the sensors have color-coded caps and the sockets are identified with colored triangles, corresponding to the colors of the sensors (pH - red; EC - blue; DO - white).

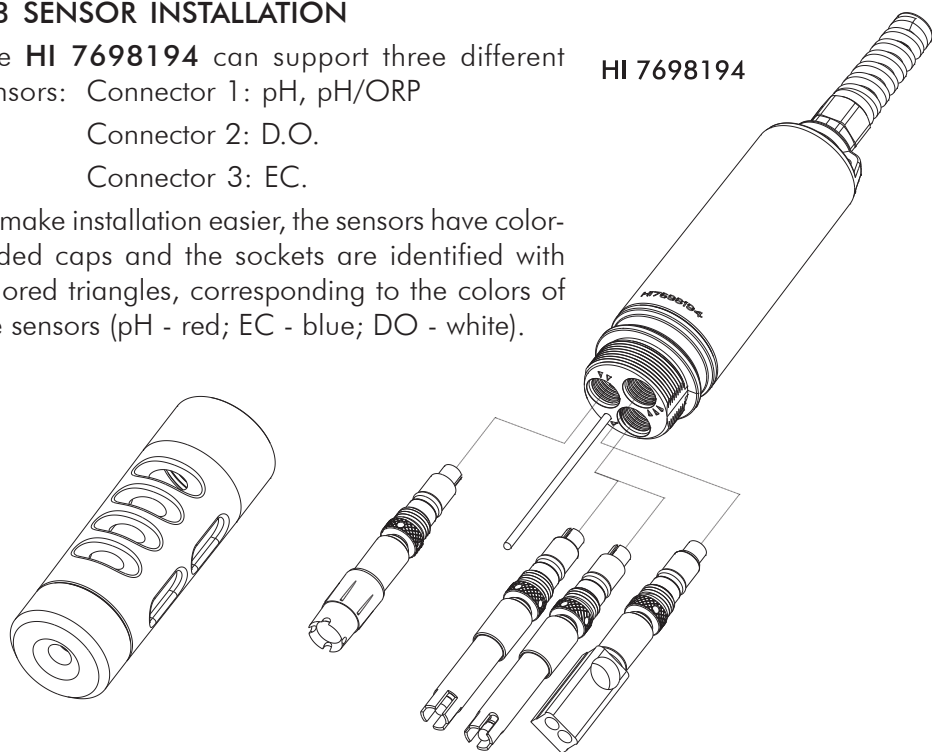

HI 7698194

The **HI 7698195** support two different sensors:

Connector 1: pH, pH/ORP

Connector 2: EC

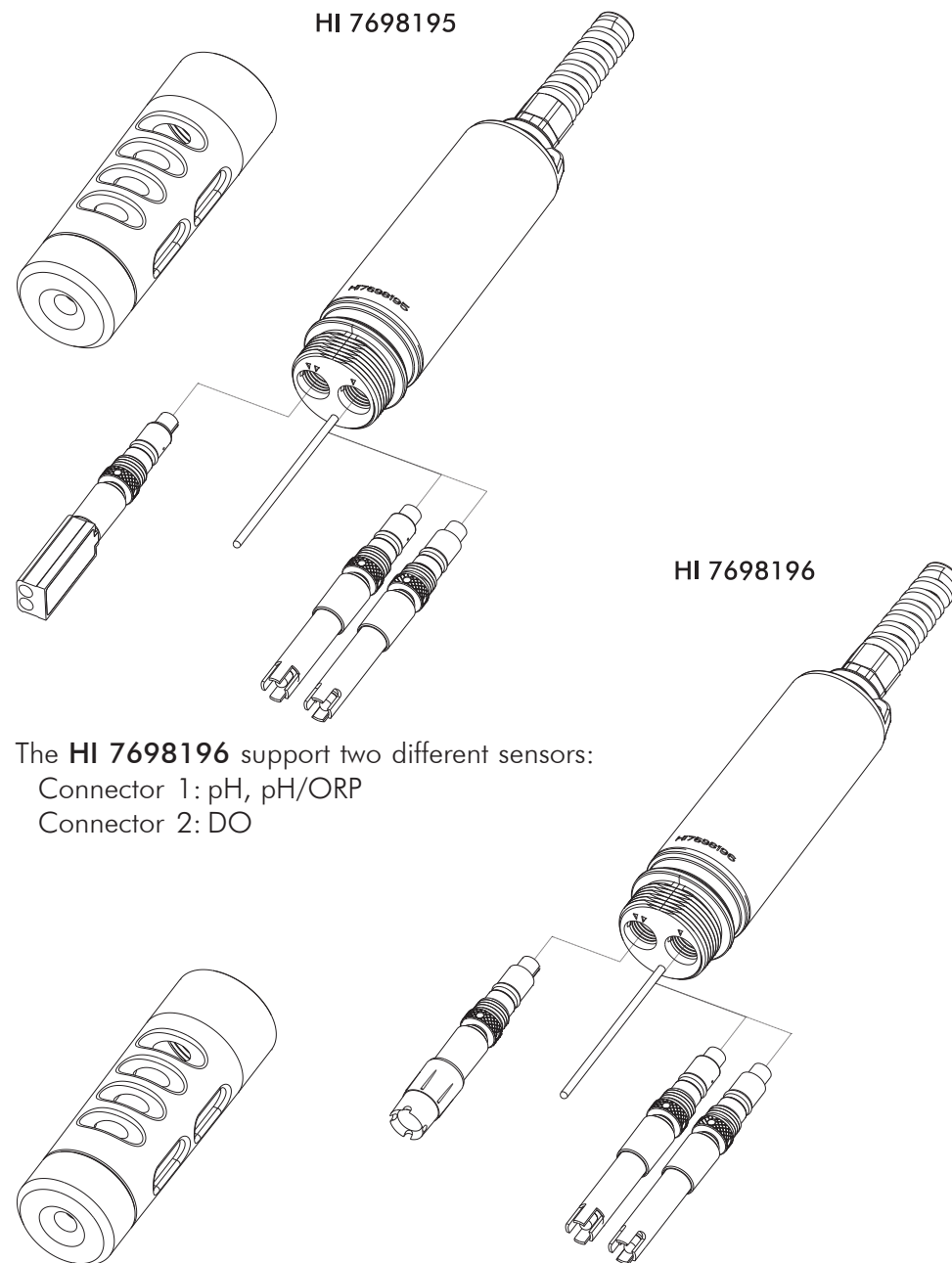

HI 7698195

HI 7698196

The **HI 7698196** support two different sensors:

Connector 1: pH, pH/ORP

Connector 2: DO

For a correct installation:

- Grease the sensor O-ring with the lubricant found in the probe maintenance kit. DO NOT SUBSTITUTE other grease/lubricants as it may cause the O-ring to swell.
- Insert the sensor into the correctly color coded opening while positioning the connector key toward the center of the probe. Make sure the connector is seated correctly (the sensor will no longer move freely) before tightening the locking threads with your fingers.
- Continue to tighten the locking threads with the tool supplied in the maintenance kit until the sensor is secured tightly against the probe body.
- To protect the sensors, screw the protective shield onto the probe body.
- With the meter off, connect the probe to the DIN socket on the bottom of the meter. Align the pins and key then push the plug into the socket. Secure the probe by attaching the carabinier of the probe to the meter piston.
- Turn on the meter by pressing the ON/OFF key. The meter should automatically recognize the installed sensors and identify them on the probe status screen. If you have an error message or the sensor is not recognized, reconnect the sensor(s) or probe and try again.



Chapter 5 - INITIALIZATION AND MEASUREMENT

5.1 BATTERY INSTALLATION

HI 9819X are supplied with 4 alkaline, size AA batteries.

The battery symbol on the LCD indicates the remaining battery life. The meter has a low battery warning, and when the symbol starts blinking, batteries should be replaced with new ones. When the batteries are discharged the meter will automatically shut off to avoid erroneous readings.

Replace batteries in nonhazardous areas only.

Remove the 4 screws on the rear of the instrument and insert the batteries observing polarity.

Note: Do not mix old and new alkaline batteries.

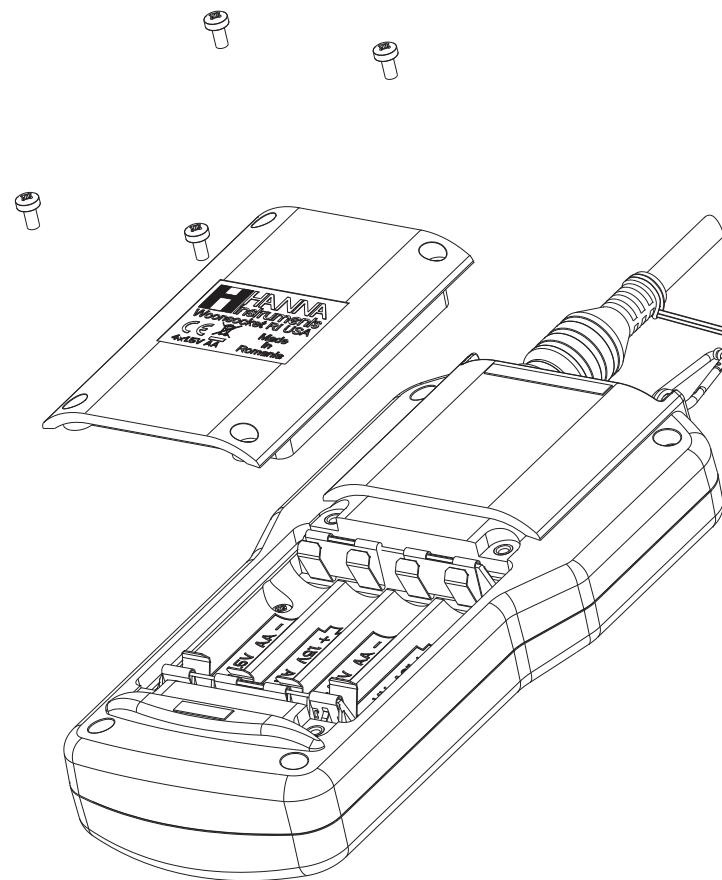

5.2 METER INITIALIZATION

After connecting the desired sensors to the probe and connecting the probe to the meter (see previous chapter), turn the meter on by pressing ON/OFF.

After the initialization has been completed if the probe is connected, the meter displays the PROBE STATUS SCREEN. The probe status screen identifies the probe and attached sensors. If an incompatible probe was connected the following message appears and the probe has to be replaced. The compatible meter-probe pairs are: **HI 98194 - HI 7698194; HI 98195 - HI 7698195; HI 98196 - HI 7698196.**

If an incompatible sensor was connected to the probe, “**Incompat.sensord!**” will be displayed according to the respective connector. If the sensor was placed in a wrong connector, “**Wrong input**” will be displayed for that connector.

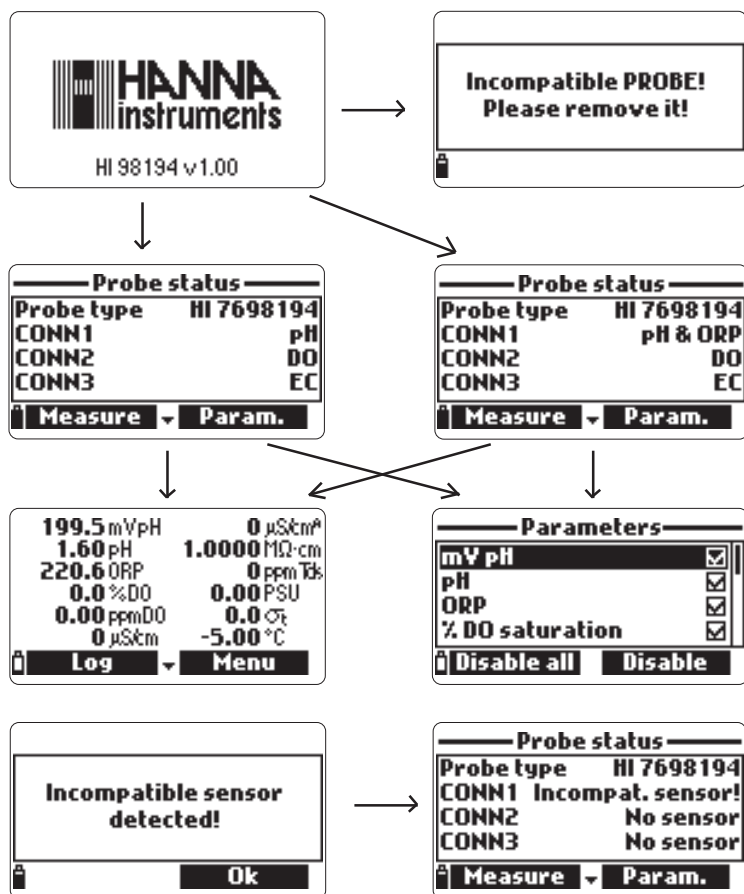

Two active soft keys are found at the bottom of the status screen.

- Press **Measure** to access the measurement mode.
- Press **Param** to access the “Select Parameter” menu. (This screen can also be accessed from the main menu, see Chapter 6 for a detailed description.).
- Press the DOWN arrow to view additional information about the probe.

5.3 MEASUREMENT MODE

Measurement mode is one of the three main operating modes of **HI 9819X** (along with logging mode and setup mode).

During measurement mode **HI 9819X** will simultaneously measure data for all enabled parameters.

- Use the numbers on the keyboard to select the number of parameters that are shown on the screen at one time. The display will automatically resize the font.

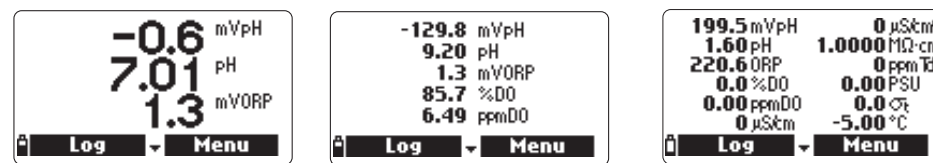

- Press the [up] and [down] arrows to scroll through the enabled parameters if they do not fit on one screen.

Note A flashing measurement value indicates that the measurement is out of range.

A flashing measurement unit indicates that the user calibration has not been done and is needed for accurate readings.

- Press **Log** to enter the log menu. See Chapter 11 for details.
- Press **Menu** to enter the main setup menu. The main menu accesses the parameter setup, calibration, system setup and status options. See the following chapters for details.

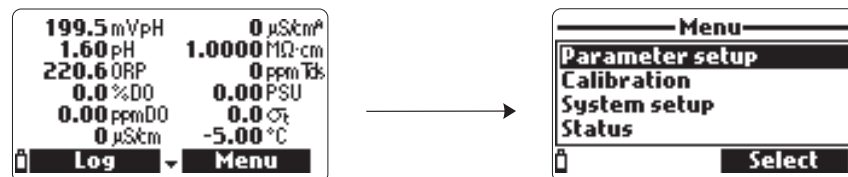

5.4 SETUP MENU STRUCTURE

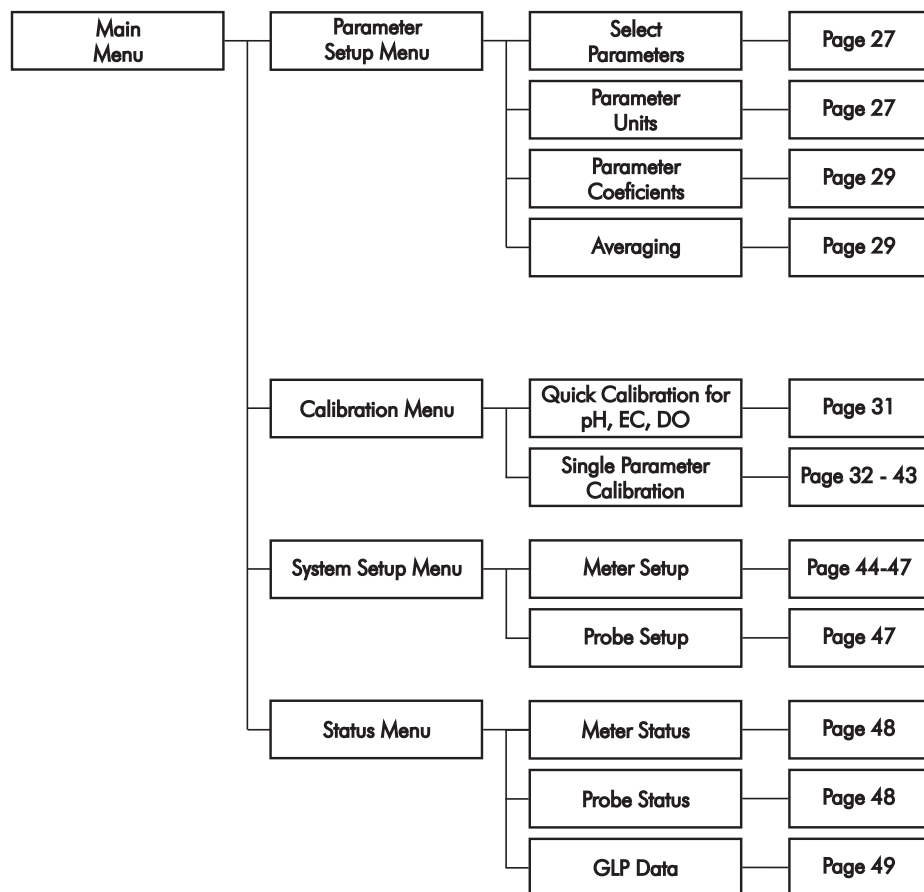

Chapter 6 - PARAMETER SETUP MENU

From the main menu, use the arrow keys to highlight *Parameter Setup* and then press **Select**. The following options will be displayed:

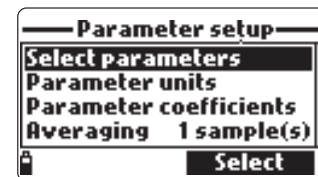

6.1 SELECT PARAMETERS

Use the **ARROW** keys to scroll through the menu. Press the right softkey to enable or disable a single parameter, or the left softkey to enable or disable all parameters. A checked box means that the parameter is enabled.

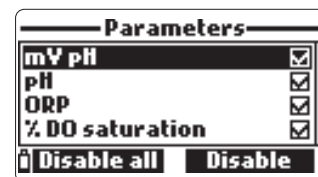

Only the available parameters are present in the list.

Note If the password protection is enabled, you will be required to enter the password before any parameters can be modified.

6.2 PARAMETER UNITS

6.2.1 Temperature Unit

The user can select the measurement unit: °C, °F or K. The default value is °C.

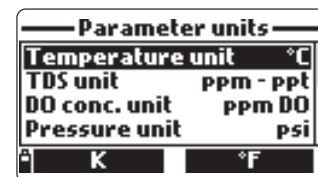

6.2.2 TDS Unit (HI 98194, HI 98195 only)

The user can select ppm - ppt or mg/L - g/L measurement unit. The default value is ppm - ppt.

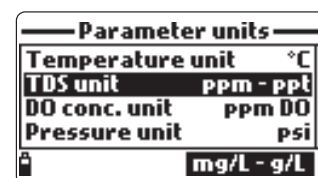

6.2.3 DO Concentration Unit (HI 98194)

The user can select ppm or mg/L. Dissolved Oxygen concentration is calculated using % saturation, conductivity and atmospheric pressure. The default value is ppm.

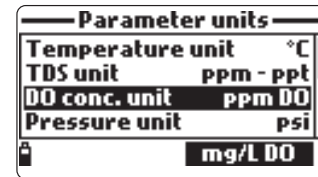

6.2.4 Pressure Unit

The user can select one the following measurement units: psi, mmHg, inHg, mbar, atm, kPA. The default value is psi.

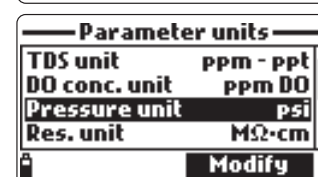

6.2.5 Resistivity Unit (HI 98194, HI 98195 only)

The user can select resistivity from one of the following measurement units: $\Omega \cdot \text{cm}$, $\text{k}\Omega \cdot \text{cm}$ or $\text{M}\Omega \cdot \text{cm}$. Resistivity is calculated from the conductivity measurement. The default unit is $\text{M}\Omega \cdot \text{cm}$.

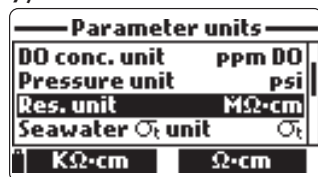

6.2.6 Seawater Sigma Unit (HI 98194, HI 98195 only)

This parameter is used for seawater analysis. It is calculated from the conductivity measurement and depends on water pressure, temperature and salinity. The default value is σ_t .

Users can select the reference temperature: σ_t , σ_0 and σ_{15} (i.e. current temperature, 0 °C or 15 °C).

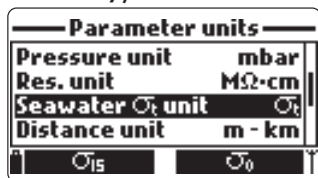

6.2.7 EC Resolution (HI 98194, HI 98195 only)

The user can configure the conductivity resolution with one of the following options:

Auto: the meter automatically chooses the range to optimize the measurement. Readings can be in $\mu\text{S}/\text{cm}$ or mS/cm .

Auto mS/cm: the meter automatically chooses the range to optimize the measurement, readings will be in mS/cm only.

1 $\mu\text{S}/\text{cm}$, 0.001 mS/cm , 0.01 mS/cm , 0.1 mS/cm or 1 mS/cm : the meter will not autorange, the measurement will be displayed with the selected resolution. The default value is Auto.

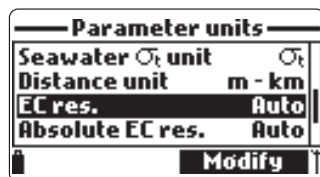

6.2.8 Absolute EC Resolution (HI 98194, HI 98195 only)

Absolute conductivity displays the conductivity without temperature compensation. See 6.2.8 EC resolution for resolution details.

Note A small letter "A" added to the $\mu\text{S}/\text{cm}$ or mS/cm unit refers to an absolute conductivity value (i.e. a conductivity reading with no temperature compensation).

6.2.9 TDS Resolution (HI 98194, HI 98195 only)

The user can configure the TDS resolution with one of the following options:

Auto: the meter automatically chooses the range to optimize the measurement, readings can be in ppt or ppm.

Auto ppt: the meter automatically chooses the range to optimize the measurement, readings will be in ppt only.

1 ppm, 0.001 ppt, 0.01 ppt, 0.1 ppt or 1 ppt: the meter will display the measurement with selected resolution. The default value is Auto.

6.3 PARAMETER COEFFICIENTS

6.3.1 EC Reference Temperature (HI 98194, HI 98195 only)

This value is used for temperature compensated conductivity. All EC measurements will be referenced to the conductivity of a sample at this temperature. Press the softkey to select the desired option; 20 °C or at 25 °C. The default value is 25 °C.

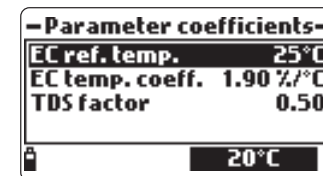

6.3.2 EC Temperature Coefficient (HI 98194, HI 98195 only)

The temperature coefficient Beta (β) is defined by the following equation (using 25 °C as an example):

$$EC_{25} = EC_x / (1 + \beta(T_x - 25))$$

Beta is a function of the solution being measured. For freshwater samples Beta is approximately 1.90%/°C. If the actual temperature coefficient of your sample is known, press **Modify** to enter the value. To confirm press **Accept**. The value can be within 0.00 and 6.00%/°C. The default value is 1.90%/°C.

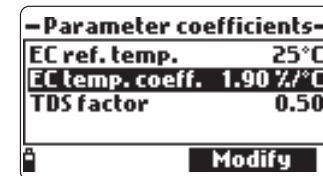

6.3.3 TDS Factor (HI 98194, HI 98195 only)

TDS stands for total dissolved solids, and it is a calculated value based on the conductivity of the solution ($\text{TDS} = \text{factor} \times EC_{25}$). The TDS conversion factor can be set from 0.00 to 1.00. A typical TDS factor for strong ionic solutions is 0.5, while for weak ionic solutions (e.g. fertilizers) is 0.7. Press **Modify** to enter the value, press **Accept** to confirm. The default value is 0.50.

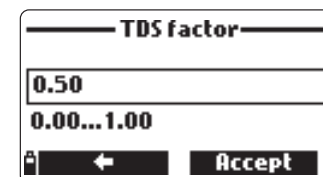

6.4 Averaging

Averaging is a software filter to minimize sensor noise and provide more stable readings. Averaging is particularly useful to get a representative reading of the "average" value from flowing water. Averaging will affect all measurements. This value should be kept low if you want a fast response. Press **Modify** to select the desired number of samples to average. This value can be set from 1 to 20 samples. The default value is 1.

Note Each reading takes 1 second, so when logging the first sample will be delayed by a few seconds if averaging is used.

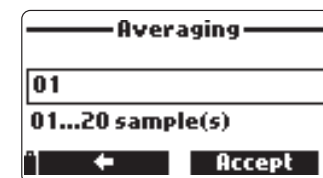
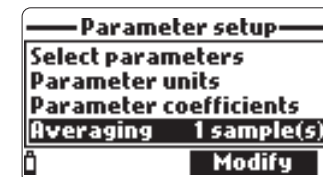

Chapter 7 - CALIBRATION MODE

HI 9819X's calibration routines are accessed by highlighting "Calibration" and pressing **Select** from the main menu. Calibration is the process that standardizes the electrical signal from the sensors to reagent standards of known value.

Calibrations are intuitive and menu driven. All calibration data is stored in the non volatile probe memory, allowing probes to be connected to different meters without recalibration.

There are two types of calibrations available: the "Quick calibration", which is used for a single point calibration of pH, Conductivity, and/or Dissolved Oxygen and is handy for field work; and the "Single param. calibration" that allows each parameter to be calibrated individually. The user may also restore each parameter to a factory default calibration.

Note The password will be required if password protection is enabled.

To optimize measurements, it is advisable to establish the optimum calibration period required for the measurement environment.

Calibration requirements vary with deployment conditions, for example very turbid biologically-active waters may require more frequent cleanings and calibrations than cleaner waters.

General calibration guidelines are listed below:

- Set up a routine service schedule where measurement integrity is validated. This is especially important for new installation sites or long deployments.
- Inspect sensor connectors for corrosion and replace damaged sensors.
- Inspect sensor o-rings for damage and if necessary replace and lubricate with the grease found in the probe maintenance kit.
- Do not handle the sensing surfaces of the sensors.
- Avoid rough handling and abrasive environments that can scratch the reactive surfaces of the sensors.
- Avoid long-term exposure of sensors to bright sunlight. If possible, calibrate in a shaded area.
- Discard standards after use. Do not return the used standards to the bottles of "fresh" solution.
- For measurements across a temperature gradient (when water temperature is drastically different from the standards), permit the sensors to reach thermal equilibrium before conducting calibrations or making measurements. The heat capacity of the probe is much greater than the air and the small beakers of calibration standards.

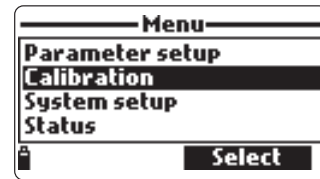

7.1 QUICK CALIBRATION

The quick calibration method provides a quick single point calibration for pH, conductivity and dissolved oxygen sensors. HI 9828-25 calibration solution is used for both pH and conductivity.

- Fill the calibration beaker 2/3 full with HI 9828-25 calibration solution.
- Slowly place the sensors into the solution and dislodge bubbles that may adhere to the sensors.
- Screw the calibration beaker completely on the probe body. Some solution may overflow.
- Wait a few minutes for the system to stabilize.
- From the "Calibration" menu select "Quick calibration".

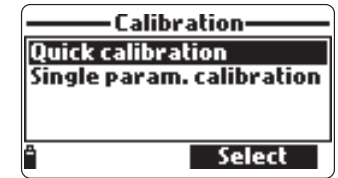

- A three item calibration menu will appear (pH, Conductivity and Dissolved oxygen) and "pH" will start to blink along with the "Not ready" message.

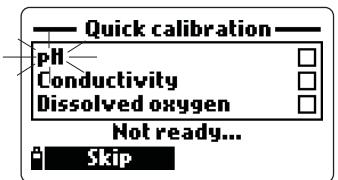

- When the pH signal is stable, the "Ready" message appears. Press **Confirm** to store the calibration data.

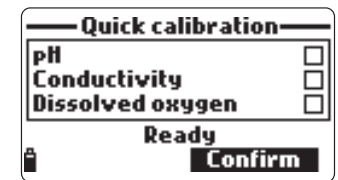

- The "Storing" message will appear as the calibration proceeds to the next sensor. A checkmark will appear in the box next to "pH" to indicate a successful calibration.

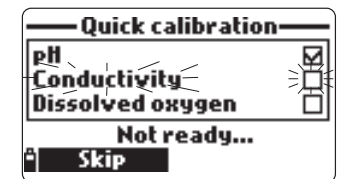

Note To bypass any of the calibrations press **Skip** to move to the next sensor in the quick calibration menu.

If the pH sensor is not installed the message "pH sensor not installed! Skip to conductivity calibration" will appear.

- Following the pH calibration, "Conductivity" will start to blink along with the "Not ready" message.
- When the measurement is stable, "Ready" appears. Press **Confirm** to store the calibration data and the "Storing" message will appear.

Note If EC calibration is not required, skip to the D.O. quick calibration by pressing the **Skip** softkey.

- The message "Empty the beaker." will appear.

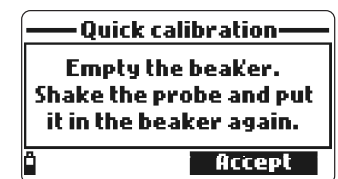

- Unscrew the calibration beaker and empty the solution.
- Shake any remaining liquid off the probe and beaker. No droplets should remain on the D.O. sensor membrane.

Note Do not attempt to dry wipe the D.O. sensor as damage to the membrane may occur.

- Screw the empty calibration beaker on the probe body. The beaker should not be dry.
- Press **Accept** to close the displayed message.
- When the measurement is stable, "Ready" appears. Press **Confirm** to store the calibration data and the "Storing" message will appear.
- Press **OK** to return to "Calibration" menu.

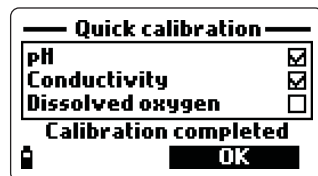

Note To quit the quick calibration procedure, press **ESC** at any time.

After every calibration the quick calibration window will show a check mark in the box next to the calibrated parameter.

7.2 pH CALIBRATION

To optimize the pH measurement follow the general guidelines mentioned in the Chapter 7 introduction.

From the "Calibration" menu select "Single param. calibration" and then "pH calibration". The display shows two options: "Calibrate pH" and "Restore factory calib."

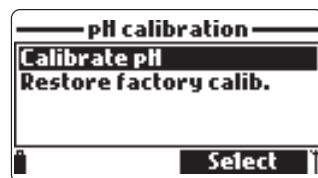

If a new pH sensor has been installed use "Restore factory calib." before performing a user calibration as some warning messages are based on changes from previous calibrations.

If "Restore Factory Calib" is selected, all user calibration data will be deleted and the default calibration is restored. A user calibration should follow immediately. If "Calibrate pH" is selected, the user can perform a new calibration using up to 3 buffers (pH 4.01, 6.86, 7.01, 9.18, 10.01 or one custom buffer).

When a 3-point calibration is performed, all old data are overwritten, while with a single or 2-point calibration the meter will also use information from the previous calibration, if exists.

7.2.1 Preparation

Pour small quantities of the selected buffer solutions into clean beakers. To minimize cross contamination, use two beakers for each buffer solution: the first one for rinsing the sensor and the second one for calibration.

7.2.2 Procedure

The measured pH value is displayed, along with the temperature and the buffer value on the second level.

If necessary, press the **Cal point** softkey and use the arrow keys to select the correct buffer.

- Immerse the sensors in the first buffer rinse solution and stir gently.
- Immerse the pH sensor and temperature probe into the selected buffer and stir gently. The temperature, pH buffer value and the "Not ready" message are displayed.
- Once the reading has stabilized the countdown timer will count down until the display shows the "Ready" message.
- Press **Confirm** to accept the calibration point.
- After the calibration point is confirmed, to avoid cross-contamination immerse the sensors in the next calibration buffer rinse solution and stir gently.
- Press **Cal Point** to select the next buffer (if necessary), and repeat the calibration procedure outlined above with the second and third buffers.

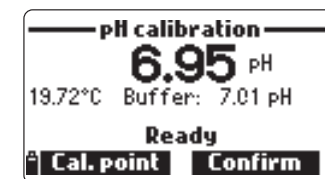
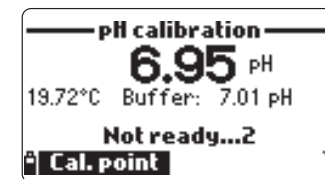

Note The calibration procedure can be terminated after a single or 2 point calibration by pressing **ESC**. The message "Storing" followed by "Calibration completed" will be displayed.

- Press **OK** to return to the Calibration menu.
- Press **Measure** to return to the measurement screen.

Custom buffer calibration

- The **HI 9819X** permits a single custom buffer to be used for pH calibration. This can be used along with standard buffers as part of a 2 or 3 point calibration or as a single point.
- To select this option first press **Cal. point** and then **Custom** while the meter is waiting for stable reading.
- A text box window will appear. Use the keypad to enter the value of the buffer at the current temperature. The valid range for custom a buffer is from 0.00 to 14.00 pH.

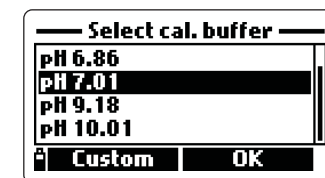

7.2.3 pH Calibration Error Messages

The **HI 9819X** displays a series of messages if an error has occurred during calibration.

If the meter does not accept a pH calibration point, a short message is displayed to indicate the possible error source. The following screens are examples:

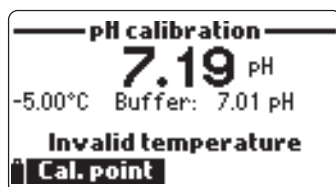
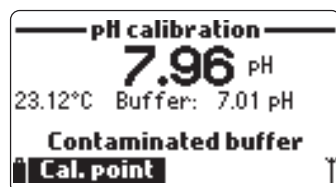
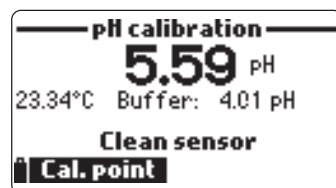
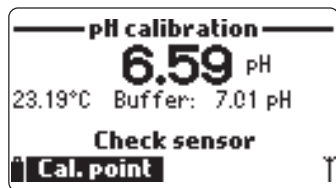

These are the available messages:

- "Input out of scale": the pH value is out of range. The pH sensor may require replacement.
- "Check sensor": the electrode may be broken, very dirty or the user has attempted to calibrate the same buffer value twice.
- "Wrong buffer": the displayed pH reading is too far from the selected buffer value. This is often seen immediately after a buffer calibration has been completed but before the pH sensor has been moved to the next buffer. Check if the correct calibration buffer has been selected.
- "Invalid temperature": the buffer temperature is outside the acceptable range.
- "Wrong buffer" / "Contaminated buffer" / "Check electrode": the buffer is contaminated or the sensor is broken or very dirty.
- "Check sensor" / "Clean sensor": the electrode is broken or very dirty.
- "Wrong" / "Clear old calibration": erroneous slope condition. These messages appear if the slope difference between the current and previous calibration exceeds the slope window (80% to 110%). Press the **Clear** softkey to cancel the old data and continue the calibration procedure, or press ESC to quit the pH calibration mode.

7.3 Relative mV CALIBRATION

The "ORP calibration" allows the user to perform a single point custom calibration (relative mV) or to restore the factory calibration.

The Oxidation-Reduction Potential (ORP), displayed in mV, is the voltage that results from the difference in potential between the platinum ORP sensor and the silver/silver chloride reference electrode. ORP values are not temperature compensated, although ORP values can change with temperature (e.g. reference electrode potential changes, sample equilibrium changes). It is important to report ORP values together with the reference electrode used and the temperature.

The inert platinum ORP surface provides an electron exchange site with the sample (or standard) and its surface. The electron exchange is typically very fast in well-poised solutions (standards for example), but may be more lengthy in natural water samples.

Calibration is typically not required for a new ORP sensor, but the process does establish a baseline that can be used as a comparison for future validations.

Calibration is used to compensate for changes due to contamination of the platinum surface and drift in the reference electrode.

A relative mV calibration can also be made to remove the voltage attributable to the Ag/AgCl reference electrode (to display the ORP versus a SHE (standard hydrogen electrode)). This is really an arithmetic correction and is correct only at the standard temperature. For example, **HI 7022L** reads 470 mV at 20 °C versus the Ag/AgCl reference. The ORP mV versus a SHE would be 675 mV. (add 205 mV to the observed value).

7.3.1 Preparation

Appendix D – ACCESSORIES lists Hanna solutions used for ORP calibrations. The calibration should be conducted at temperatures between 20-26 °C. The sensor should be clean and oil free.

7.3.2 Procedure

- From the “Calibration” menu select “Single param. calibration” and then “ORP calibration”. The display shows two options: “Custom ORP” and “Restore factory calib.”.
- For a user calibration select “Custom ORP”.
- Fill a beaker with an ORP test solution (see APPENDIX D “Accessories”).
- Using the keypad, insert the numerical ORP value and then press **Accept** to confirm.
- The stability counter will count down and the message “Ready” and **Confirm** will be displayed.
- Press **Confirm** to accept the calibration point.
- After confirmation, the following messages are displayed: “Storing” and “Calibration completed”.
- Press **OK** to return to the Calibration menu.
- Press **Measure** to return to the measurement screen.
- To restore the factory calibration data, select the corresponding option in the “ORP calibration” menu and then press **Select**.

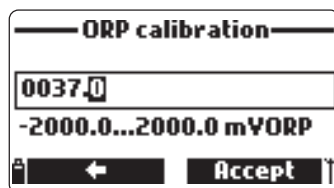

7.4 DISSOLVED OXYGEN CALIBRATION (HI 98194, HI 98196 only)

The accuracy of dissolved oxygen measurements is directly related to membrane cleanliness and calibration technique. Oily coating and biological contaminants are the primary cause of calibration drift in dissolved oxygen sensors. Unfortunately, brushes or other cleaning objects may damage the membrane. Replacing the membrane cap and electrolyte is the best way to perform periodic maintenance.

Although it may be easier to calibrate the D.O. sensor prior to deployment, it is advised to calibrate at the site of deployment. Errors in measurement may result if altitude and barometric pressure differ between the calibration and measurement site. This is very important for autonomously logging probes.

Note Perform either the % D.O. Saturation or D.O. Concentration calibration.

If the % D.O. saturation range is calibrated, the D.O. concentration range will also be calibrated, and vice versa.

Dissolved oxygen concentration values are based on % D.O. saturation, temperature, salinity and atmospheric pressure. A standard solution or a reference D.O. meter may be used to compare readings during calibration.

The calibration of the D.O. concentration range can only be performed at a single custom point (4 to 50 mg/L). It is recommended to calibrate the D.O. sensor close to the values that will be measured.

Choose “DO calibration” from the “Calibration” menu, select the D.O. calibration type using the arrow keys and press **Select** to confirm.

% D.O. saturation

The calibration of the % D.O. saturation range can be performed at a single or 2 standard points (0 % and 100 %), or at a single custom point (50 % to 500 %).

Procedure:

- To calibrate at 100 %, fill the calibration beaker with approximately 4 mm (5/32") of water and screw it onto the probe. The membrane should not be wet. This condition corresponds to air 100 % saturated with oxygen and water vapor.
- The reading, temperature, calibration point and the “Not ready” message are displayed.
- Once the reading has stabilized the countdown timer will count down until the display shows the “Ready” message.
- Press **Confirm** to accept the calibration point. After confirmation, put the D.O. and temperature sensors into HI 7040L zero oxygen solution and wait for stability to be reached. The stability timer will count down and **Confirm** will appear. Press **Confirm** to store the calibration.
- The following messages will appear: “Storing” and “Calibration completed”.
- Press **OK** to return to the “Calibration” menu.
- Press **ESC** twice to return to the main menu.
- Press **Measure** to return to the measurement screen.

Note The user can perform a single point calibration by pressing **ESC** after the first point is accepted.

Note If the D.O. input is not within the acceptable range, the message “Invalid input” is displayed.

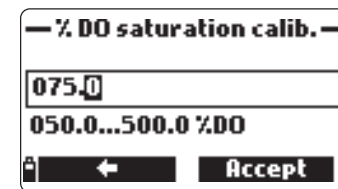
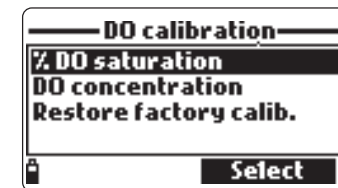

Single point Custom % saturation calibration

- For a calibration at another known value place sensor and temperature probe into the known solution and change the calibration value, press the **Cal. point** softkey and select the desired point.
- To insert a different calibration value, press **Cal. point** and then **Custom**. Insert the desired value using the keypad, then press **Accept**.
- When the reading is stable, the “Ready” message is displayed. Press **Confirm** to store the calibration point.
- The following messages will appear: “Storing” and “Calibration completed”.
- Press **OK** to return to the “Calibration” menu.
- Press **ESC** twice to return to the main menu.
- Press **Measure** to return to the measurement screen.

D.O. concentration (only HI 98194)

Verify the barometric pressure, conductivity and temperature reading are correct. Calibrate them if necessary. To calibrate the D.O. concentration range, a solution with known Dissolved Oxygen concentration value is needed. The solutions used to calibrate with should be determined independently (for instance by Winkler titration). Place the D.O. sensor with temperature sensor into the known solution.

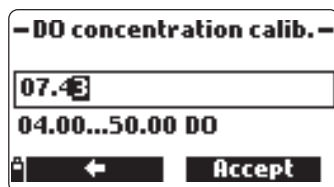

- From the “DO calibration” menu, select the “DO concentration” option, insert the known concentration. Allow the sensors to reach thermal equilibrium with the solution. Stir or agitate if possible to keep fresh solution in front of the membrane and press **OK**.
- When the reading is stable, the stability timer will count down and <Confirm> will appear. Press **Confirm** to accept the value.
- When the messages “Storing” and “Calibration completed” appear, the calibration is completed. To return to the “Calibration” menu, press **OK**.
- To return to the main menu, press **ESC** twice.

7.5 CONDUCTIVITY CALIBRATION (HI 98194, HI 98195 only)

A conductivity calibration is used to adjust for variations in cell factors by using a standard solution of known conductivity. Oily coating and biological contaminants are the primary cause of calibration drift in conductivity sensors. This type of fouling changes the apparent cell geometry, resulting in a shift in cell constant. Before performing a conductivity calibration inspect the EC sensor for debris or blockages. The EC electrodes are situated inside the two small channels found in the bottom of the conductivity sensor. Clean using the small brush from the probe maintenance kit. Flush with water. A mild detergent may be used to remove oily coatings. Always flush with clean water after cleaning.

Note For a correct conductivity calibration, the probe shield or the calibration beaker must be used.

The conductivity calibration menu includes 3 different types of calibration: Conductivity, Absolute conductivity and Salinity.

The “Conductivity” option allows a single point calibration with a standard solution selectable by the user. This calibration is temperature compensated.

The “Absolute conductivity” option allows a single point calibration with a conductivity solution of known non-temperature compensated value at the current temperature.

The “Salinity” option allows calibration with a standard salinity solution.

The 3 calibrations are related, so that each one will calibrate all 3 measurements.

Note To improve accuracy, choose a calibration standard near the sample conductivity.

Choose “Conductivity calibration” from the “Calibration” menu, select the calibration type using the arrow keys and press **Select** to confirm.

Conductivity

- Select the “Conductivity” option and press **Select** to confirm.
- Fill the calibration beaker with a conductivity standard (see APPENDIX D - “Accessories” for choosing the proper HANNA standard solution).
- Pour additional standard into a second beaker to be used to rinse the sensor.
- Immerse the sensor into the rinse standard by raising and lowering the beaker a few times to ensure that the EC sensor channels are filled with fresh standard.
- Place the calibration beaker over the EC sensor and dislodge any trapped bubbles. Screw the beaker into place. Wait for the reading to stabilize.

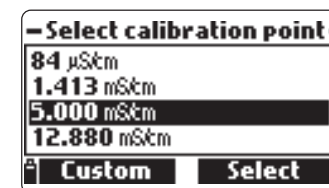
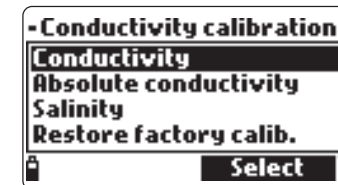

- The main display shows the actual reading, while the secondary level displays the current temperature and the standard value.
- To change the standard value, press **Cal. point** and the list of available standard values is displayed: 0 µS/cm, 84 µS/cm, 1413 µS/cm, 5.00 mS/cm, 12.88 mS/cm, 80.0 mS/cm and 111.8 mS/cm.

- The third level displays the status message.
- Press **Custom** to insert a custom value (temperature compensated value). Insert the desired value using the keypad, then press **Accept**.
- When the reading becomes stable, the stability timer will count down and **Confirm** will appear. Press **Confirm** to save the calibration.
- After confirmation, the following messages are displayed: “Storing” and “Calibration completed”.
- Press **OK** to return to the “Calibration” menu.
- Press **ESC** twice to return to main menu.
- Press **Measure** to return to the measurement screen.

Absolute Conductivity

- Select “Absolute conductivity” from the “Conductivity calibration” menu.
- Use the keypad to enter the custom value with the desired resolution. Press **Accept** to confirm.
- Fill the calibration beaker with conductivity standard with known conductivity at the temperature of standardization.
- Pour additional standard into a second beaker to be used to rinse the sensor.
- Immerse the sensor into the rinse beaker and raise and lower the beaker to ensure that the EC sensor channels are filled with fresh standard.
- Place the calibration beaker over the EC sensor and dislodge any trapped bubbles. Screw the beaker into place.
- Wait for the reading to stabilize. The stability timer will count down and **Confirm** will appear.
- Note the temperature and adjust the conductivity value if needed.
- Press **Confirm** to save the calibration.
- After confirmation, the following messages are displayed: “Storing” and “Calibration completed”.
- Press **OK** to return to the “Calibration” menu.
- Press **ESC** twice to return to the main menu.
- Press **Measure** to return to the measurement screen.

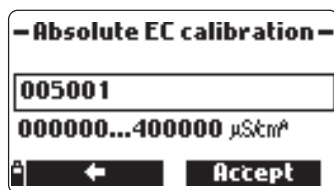

Salinity

The measurement of salinity is based on the Practical Salinity Scale which uses the EC measurement. If the user has a standard with known PSU value it may be used to calibrate the conductivity sensor.

- Select “Salinity” from the “Conductivity calibration” menu.
- Use the keypad to enter the known salinity value of the calibration solution. Press **Accept** to confirm.
- Fill the calibration beaker with salinity standard of known value.
- Pour additional standard into a second beaker to be used to rinse the sensor.
- Immerse the sensor into the rinse beaker and raise and lower the beaker to ensure that the EC sensor channels are filled with fresh standard.
- Place the calibration beaker with standard over the EC sensor and dislodge any trapped gas bubbles. Screw the beaker into place.
- Wait for the reading to stabilize. The stability timer will count down and **Confirm** will appear.
- Note the temperature and adjust the salinity value if needed.
- Press **Confirm** to save the calibration.
- After confirmation, the following messages are displayed: “Storing” and “Calibration completed”.
- Press **OK** to return to the “Calibration” menu.
- Press **ESC** twice to return to the main menu.
- Press **Measure** to return to the measurement screen.

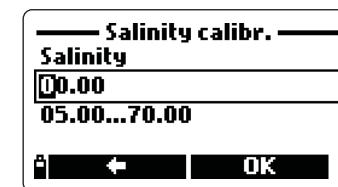

Notes These procedures calibrate the slope value. To calibrate the offset, set the calibration point at 0 $\mu\text{S}/\text{cm}$ and repeat the procedure.

If the temperature input is not within the acceptable range (0 to 50°C), the message “Invalid temperature” is displayed.

If the conductivity input is not within the acceptable range, the message “Wrong standard” is displayed.



7.6 TEMPERATURE CALIBRATION

The probe is factory calibrated for temperature readings. The user can perform a single point temperature calibration or restore factory calibration. This procedure requires a reference temperature measuring instrument.

- Select “Temperature” from the “Calibration” menu.
- Select “Calibrate temperature”.
- Insert the probe in an isothermal bath with reference instrument and allow the probe to come to thermal equilibrium.
- Use the keypad to enter the known temperature and then press **Accept** to confirm.
- The stability timer will count down and the message “Ready” and “Confirm” will be displayed.
- Press **Confirm** to store the calibration point.
- After confirmation, the following messages are displayed “Storing” and “Calibration completed”.
- Press **OK** to return to the “Calibration” menu.
- Press **Measure** to return to the measurement screen.
- To restore the factory calibration, select the corresponding option in the “Temperature calib.” menu and then press **Select**.

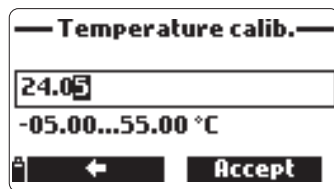

7.7 ATMOSPHERIC PRESSURE CALIBRATION

Place **HI 9819X** in a wind-free area and choose “Custom pressure” to perform a user calibration or “Restore factory calib”.

Note “Custom pressure” procedure requires a reference barometer.

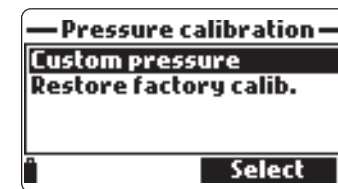

Select the “Atm. pressure” from the “Calibration” menu.

- Select the “Custom pressure” option.
- Using the keypad, insert the numeric value that agrees with the reference meter and then press **Accept** to confirm.
- The stability counter will count down and the message “Ready” and “Confirm” will be displayed. Press **Confirm** to store the calibration point.
- After confirmation, the following messages are displayed: “Storing” and “Calibration completed”.
- Press **Measure** to return to the measurement screen.
- Press **OK** to return to the “Calibration” menu.
- To restore the factory calibration, select “Restore factory calib.” in the “Pressure calibration” menu and press **Select**.

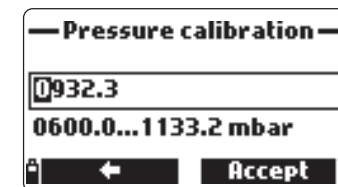

Chapter 8 - SYSTEM SETUP

From the main menu, select “System setup” and then “Meter setup” or “Probe setup”.

8.1 METER SETUP

Note If the password protection is enabled, you will be required to enter the password before any settings can be modified.

8.1.1 Time

The meter uses a real time clock for logging. The time and time format are set in this function.

Press **Modify** and set the time using the keypad. Press **Accept** to save the time. When using the 12 hour format, press A or P on the keypad for AM or PM after you set the time.

Press **Format** to change between 12 and 24 hour formats. The default format is 24 hours.

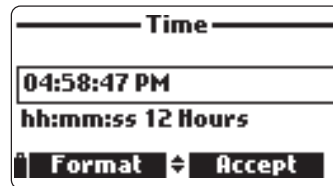
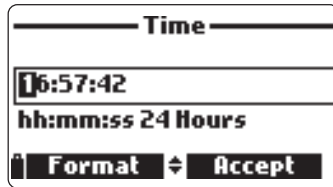

8.1.2 Date

The date and date format are set in this function. Press **Modify** and set the date using the keypad. Press **Accept** to save the date.

Press **Format** to change between the available date formats: DD/MM/YYYY, MM/DD/YYYY, YYYY/MM/DD, YYYY-MM-DD, MM-DD-YYYY, and DD-MM-YYYY. The default format is YYYY/MM/DD.

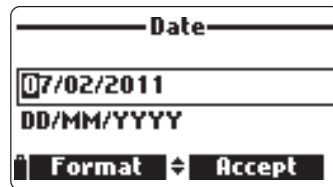
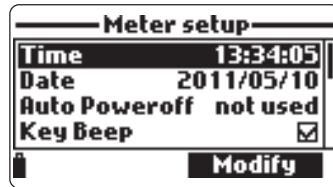
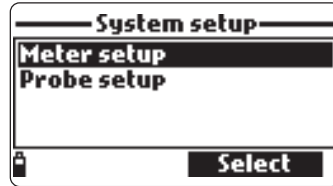
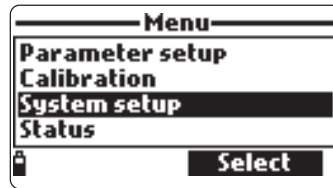

8.1.3 Auto Poweroff

The Auto Poweroff function is used to save battery life. After the set time is elapsed, the meter will:

1. automatically switch off, if in normal measurement mode. Press **On/Off** to switch on again.
2. enter a sleeping mode, if the continuous logging mode is selected with a logging interval of at least 30 seconds. The “Auto Poweroff” message and the **Wake up** softkey appear on the LCD; logging is not stopped. Press **Wake up** to reactivate the display.

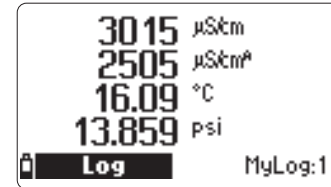
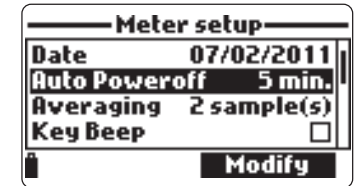

Available options are: Not used (disabled), 5, 10, 15, 20, 30 or 60 minutes. Press **Modify** to select the desired time interval. The default value is “not used”.

8.1.4 Key Beep

If enabled, an acoustic signal sounds every time a key is pressed. A checked box indicates this function has been enabled. The default setting is disabled.

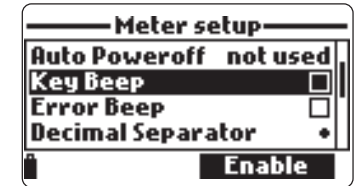

8.1.5 Error Beep

If enabled, an acoustic signal sounds every time an incorrect key is pressed, or when an error occurs. A checked box indicates this function has been enabled. The default setting is disabled.

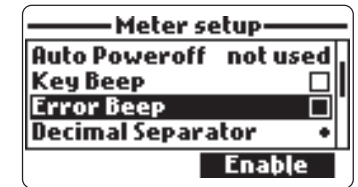

8.1.6 Decimal Separator

The user can select the type of decimal separator: “dot” or “comma”. Press the softkey to select the desired option. The default setting is “dot”.

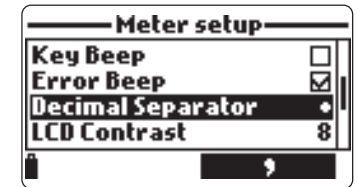

8.1.7 LCD Contrast

The LCD contrast can be adjusted with this function. Press **Modify** to enter this function. Use the **ARROW** keys to change the contrast level and press **Accept** to save the new value. The default value is 8.

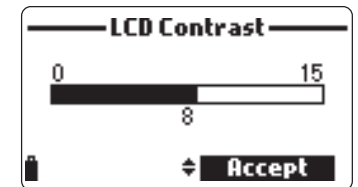

8.1.8 LCD Backlight Intensity

The LCD backlight intensity can be adjusted with this function. Use the arrow keys to change the level and press **Accept** to save the new value. The default value is 7.

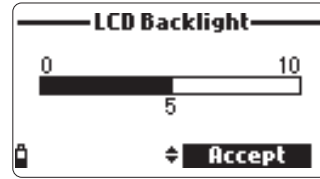

8.1.9 Meter Password

The Meter Password protects against unauthorized configuration changes and log data erasure. When implemented, many setting and functions cannot be modified or viewed.

To enable the password proceed as follows:

- Highlight “Meter Password” and press **Modify**.
- Enter the desired password in the text box and press **Accept**.

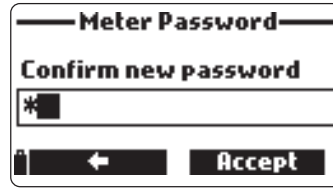
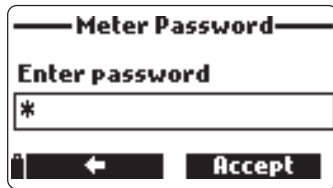

Note While typing, the characters are masked with a “*” (star) symbol.

- The meter will require password confirmation. Retype the same password and press **Accept** to confirm.
- The meter returns to the “Meter Setup” menu. The checkbox corresponding to the meter password is checked.

To disable the password protection highlight “Meter Password” and press **Modify**, enter the password and then press **Disable**. “No password” appears in the text box. Press **Accept** to confirm.

8.1.10 Meter ID

The Meter ID may be used to uniquely identify a meter/operator. Press **Modify** and a text box appears. Use the keypad to insert the desired alphanumeric ID and press **Accept** to store the identification. A maximum of 14 characters can be used.

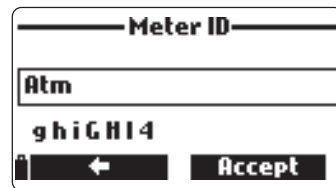

8.1.11 Language

The language used in the meter user interface can be changed. The default language is English. Please contact your local Hanna office for currently available languages.

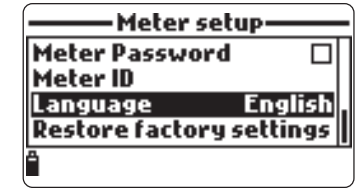

8.1.12 Restore Factory Settings

This function restores measurement settings to their original factory values. This includes measurement units, coefficients, other measurement configurations and all logged data. The factory calibration for the sensor channels is not affected.

- Select the “Restore factory settings” and press **Select**.
- The meter will ask to confirm: press **Yes** to confirm or **No** to escape.

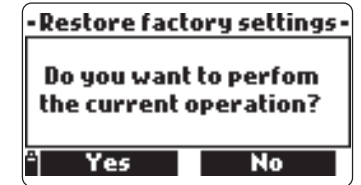

8.2 PROBE SETUP

8.2.1 Probe ID

The probe can be labeled with an identification code: press **Modify** and a text box will be displayed. Use the keypad to enter the desired alphanumeric code and then press **Accept**.

A maximum of 14 characters can be used.

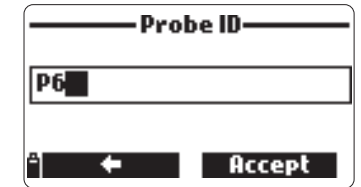

Chapter 9 - STATUS

Useful information regarding the meter, probe (if connected) and GLP calibration data are available for viewing by selecting "Status" from the main menu.

9.1 METER STATUS

Select "Meter Status" to display information related to the battery, logging, internal temperature, password, Meter ID, serial number and firmware version. Press [up] and [down] to scroll through the status screens. Press **ESC** to return to the "Status" menu.

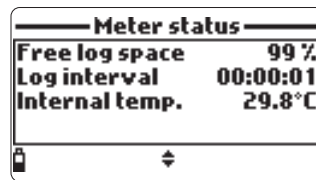
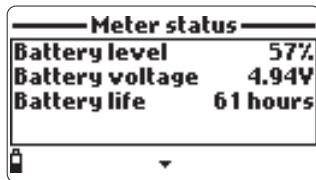
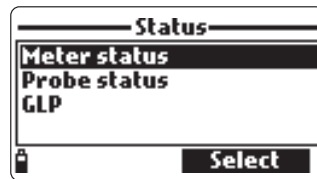
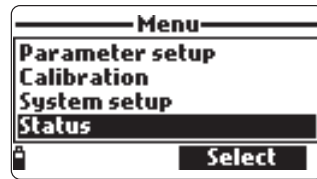

9.2 PROBE STATUS

Select "Probe Status" to display information related to the probe type, connected sensors, Probe ID, serial number and firmware version.

- Press [up] and [down] to scroll through the status screens.
- Press **ESC** to return to the "Status" menu.

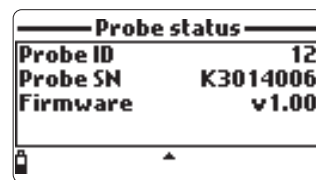
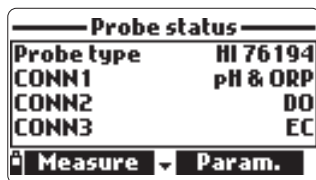
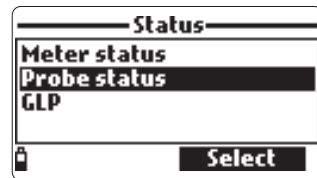

Note The probe status screen will automatically be displayed when the probe sensor status has changed. If this occurs, the "Measurement Screen" and "Parameter Selection" softkeys are available (see Section 5.2).

9.3 GLP DATA

GLP (Good Laboratory Practice) is a set of functions that allows the user to store or recall data regarding the probe calibration. This feature also allows the user to associate readings with specific calibrations.

To view GLP data select "GLP" from the "Status" menu. The complete list of available parameters appears. Select the desired parameter to view the stored GLP information.

Note If no calibration data is available for the selected parameter, the display shows the message "No GLP data available for this measurement". Press **OK** to return to the previous screen.

Note GLP data is stored for the last 5 calibrations. This calibration history allows the user to detect when readings start to change and sensors may require cleaning or replacement.

pH

- From the "GLP" menu, select the "pH" option.
- Data regarding the last pH calibration will be displayed: offset, acidic slope, basic slope, buffers used, time and date of the calibration.
- Use the arrow keys to scroll through the stored data for the last 5 calibrations.
- Press **ESC** to return to the "GLP" menu.

Note A "C" label near the buffer value indicates a custom point, while an "H" indicates a HANNA standard buffer value.

If a quick calibration was performed, the buffer values are replaced with the "Quick calibration" indication.

If no pH calibration has been performed or if calibration was cleared using the "Restore factory calib." option the offset and slope values are set to default, and the message "Factory calibration" is displayed. Press **ESC** to return to the previous screen.

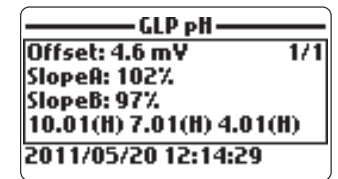
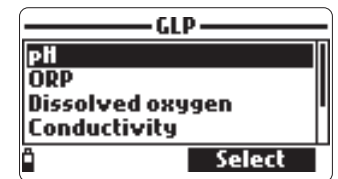
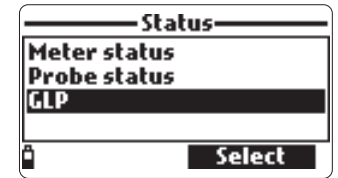
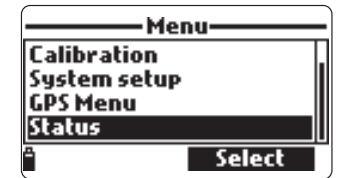

ORP

- From the “GLP” menu select the “ORP” option.
- Data regarding the last ORP calibration will be displayed: calibration point, time and date.
- Use the arrow keys to scroll through the stored data for the last 5 calibrations.
- Press **ESC** to return to the “GLP” menu.

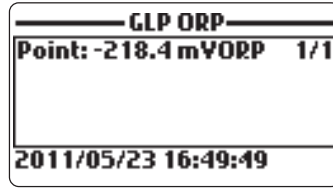

Notes If no ORP calibration has been performed or if calibration was cleared using the “Restore factory calib.” option the offset and slope values are set to default, and the message “Factory calibration” is displayed. Press **ESC** to return to the previous screen.

Dissolved Oxygen

- From the “GLP” menu select the “Dissolved oxygen” option.
- Data regarding the last D.O. calibration will be displayed: calibration points, % saturation or concentration, time and date.
- Use the arrow keys to scroll through the stored data for the last 5 calibrations.

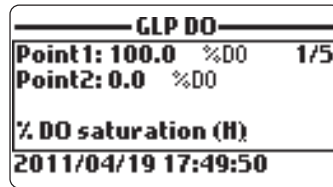

Notes A “C” label near the calibration point indicates a custom point, while an “H” indicates a HANNA standard value.

When the % D.O. range is calibrated, also the D.O. concentration range is calibrated, and vice versa.

If no D.O. calibration has been performed or if calibration was cleared using the “Restore factory calib.” option the offset and slope values are set to default, and the message “Factory calibration” is displayed. Press **ESC** to return to the previous screen.

Conductivity

- From the “GLP” menu select the “Conductivity” option.
- Data regarding the last conductivity calibration will be displayed: calibration point, cell constant value, calibration type (conductivity, absolute conductivity or salinity), time and date of the calibration.

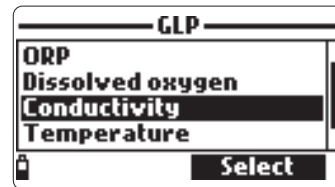

- Use the arrow keys to scroll through the stored data for the last 5 calibrations.



Notes A “C” letter near the conductivity calibration indicates a custom point, while an “H” indicates a HANNA standard value.

If no conductivity calibration has been performed or if calibration was cleared using the “Restore factory calib.” option the offset and slope values are set to default, and the message “Factory calibration” is displayed. Press **ESC** to return to the previous screen.

Temperature

- From the “GLP” menu select the “Temperature” option.
- Data regarding the last temperature calibration will be displayed: calibrated point, time and date.
- Use the arrow keys to scroll through the stored data for the last 5 calibrations.

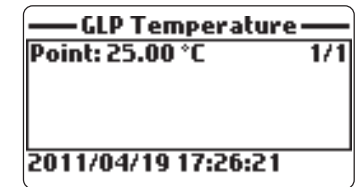

Notes If no user temperature calibration has been performed or if calibration was cleared using the “Restore factory calib.” option the offset value is set to default, and the message “Factory calibration” is displayed. Press **ESC** to return to the previous screen.

Atmospheric Pressure

- From the “GLP” menu select “Atm. pressure”.
- Data regarding the last atmospheric pressure calibration will be displayed: custom calibration point, time and date.
- Use the arrow keys to scroll through the stored data for the last 5 calibrations.

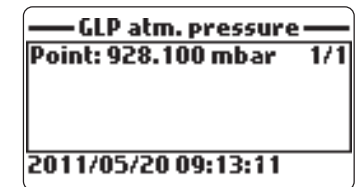

Notes If no atmospheric pressure calibration has been performed or if calibration was cleared using the “Restore factory calib.” option the offset value is set to default, and the message “Factory calibration” is displayed. Press **ESC** to return to the previous screen.

Chapter 10 - LOGGING MODE

The HI 9819X and the corresponding probe offer many logging options that can be combined based on user needs. The following figures describe the available logging options.



METER PARAMETERS ONLY

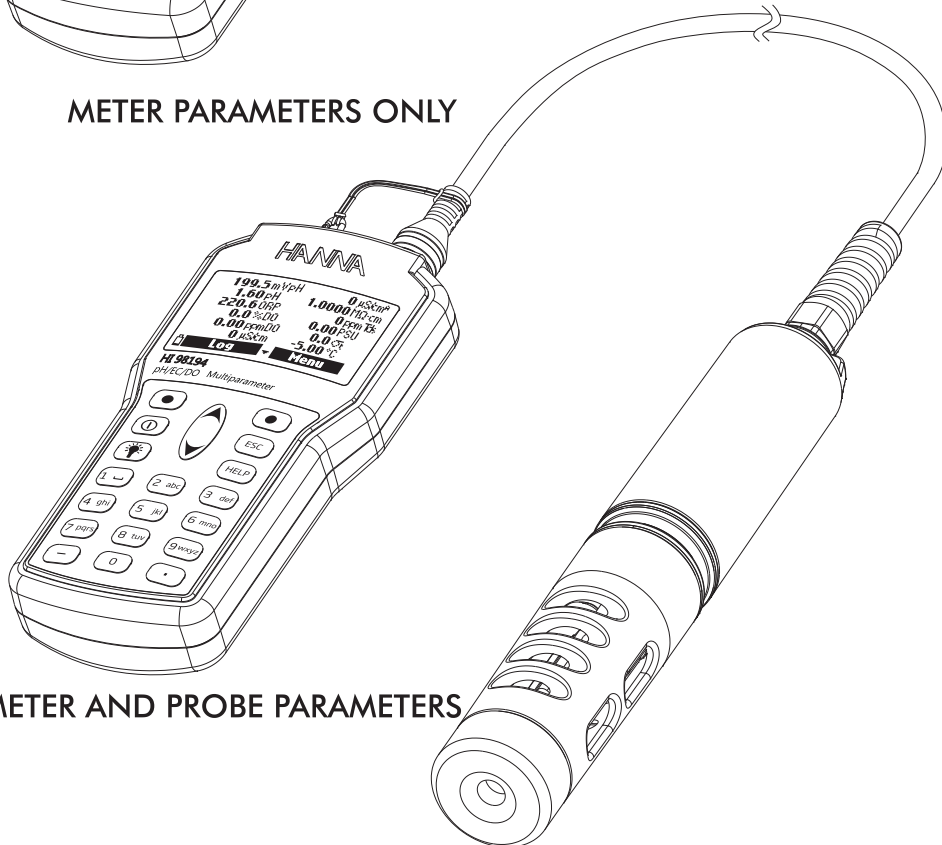

METER AND PROBE PARAMETERS

10.1 LOGGING MENU STRUCTURE

From measurement mode, press **Log** to access the log menu.

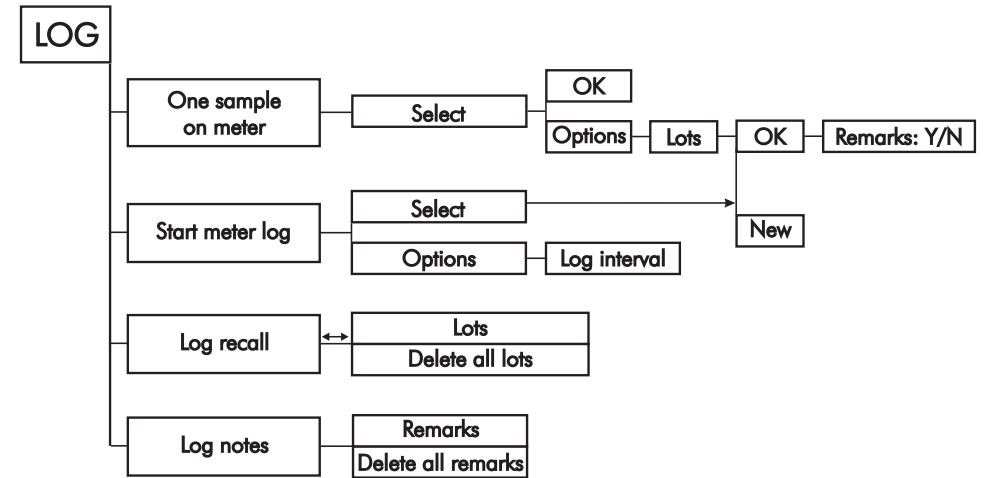

10.2 LOGGING ON METER

- The data logged on the meter are organized by lots. Up to 45,000 complete records can be stored in up to 100 lots. Each lot can store log-on-demand records and/or continuous records with different parameter configurations.

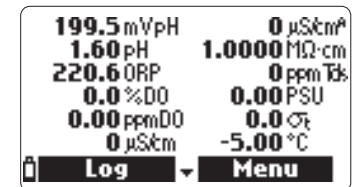

10.2.1 One Sample On Meter

Use this option to log one set of enabled measurement parameters to the meter memory.

- If there are no lots saved on the meter, press **New** to create a new lot. Use the keypad to enter the desired lot name and press **Accept** to confirm. Press **OK** to log the sample in the selected lot.
- If there are existing lots on the meter, the meter will suggest a lot to store the sample. Press **OK** to use the selected lot or **Options** to select a different lot. This will add the new sample data to an existing lot. A new lot can also be created by pressing **New**. Press **OK** to log the sample in the selected lot.
- On the “Remarks” window, select **Yes** to go to the Remarks screen. Press **No** to skip this option. If **Yes** is selected, select a remark from the list, or press **New** to create a new remark.
- To return to the measurement screen, press **ESC**.

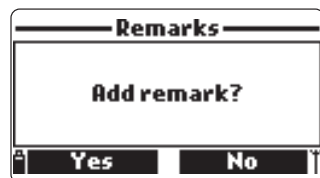
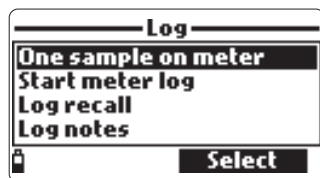

10.2.2 Continuous Meter Log

- Select “Start meter log” to log the currently enabled parameters at the set logging interval on the meter.
- To set the logging interval, highlight “Start meter log” and press **Options**. The log interval time can set from 1 second to 3 hours. Press **Modify** and use the arrow keys and keypad to enter the desired log interval. Press **Accept** to confirm.
- Press **Select** to edit the lot, remark, or tag, see section 11.4.
- To stop the meter log, enter the log menu and select “Stop meter log”.

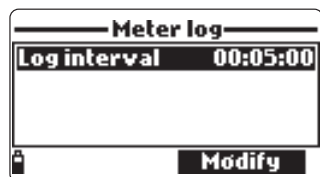
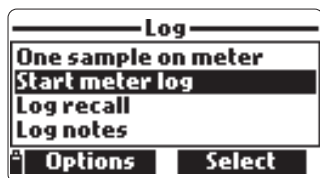

10.3 LOG RECALL

- Select “Meter log recall” to view logs that are stored on the meter. The meter will show the number of available lots. Select “Lots” to view or delete individual lots.
- Use the arrow keys to select the desired lot and then press **View**.
- The meter displays a summary of all data related to the selected lot: number of samples, memory space used, time and date of the first and last readings.
- Press **View** to display the sample details for each point. Use the arrow keys to change the sample number in the selected lot. The sample number is shown on the bottom right corner of the display.

Note Details are available only for the enabled parameters.

- Press **Info** to see record information for the current sample (time & date, remark or serial number (if available).)
- Press **Data** to return to the previous screen or **Jump** to select a different sample in the same lot. When **Jump** is pressed, a text box appears to insert the desired sample number.
- Press **ESC** to return to the menu.
- Choose “Plot” and the meter will create a list with all available parameters that can be plotted.
- Use the arrow keys to select the desired parameter. Press **Select** to view the graph.

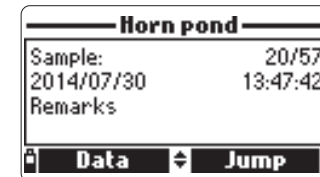
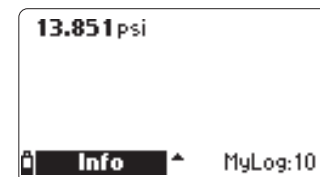
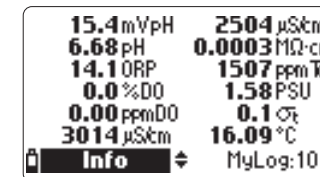
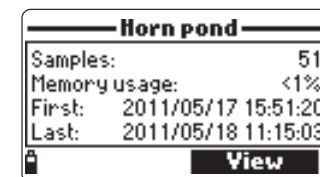
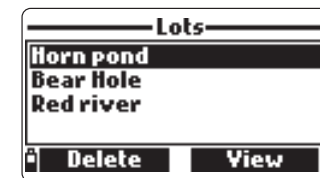
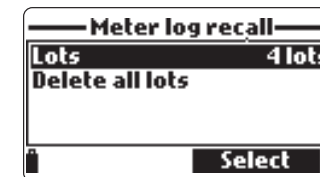

- Use the arrow keys to move the cursor in the graph and highlight a sample. The sample data are displayed below the graph.
- Press **ESC** to return to the parameter list.
- Press **ESC** again to return to the menu.

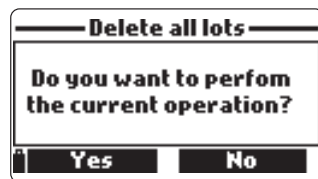
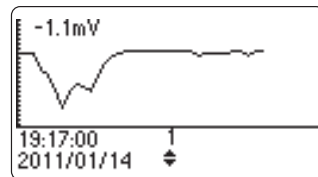
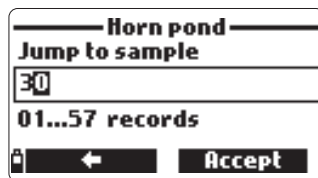

Note The number of lot samples that can be plotted is limited by the display resolution. To view a complete graph download data to PC.

Delete all lots

- From "Meter log recall" choose "Delete all lots" and the meter will display the message "Do you want to perform the current operation?". Press **Yes** to delete or **No** to return to the previous screen.
- To return to the "Log recall" menu, press **ESC**.

10.4 LOG NOTES

10.4.1 Remarks

A remark can be associated with each sample. The meter can store up to 20 remarks.

- To add a remark, select "Log notes" from the Log menu, and then select "Remarks".
- The display shows a list of stored remarks.
- Press **New** to create a new remark, and use the keypad to enter the new remark in the text box.
- Press **Delete** to delete the selected remark from the meter. If the deleted remark is used in an existing lot, the information will be still available in the lot data.

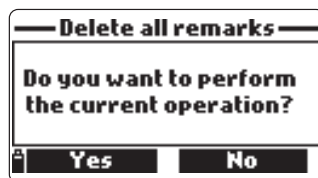
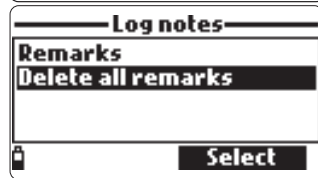
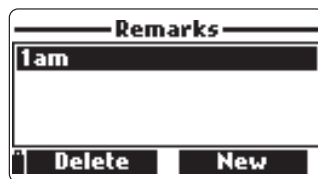
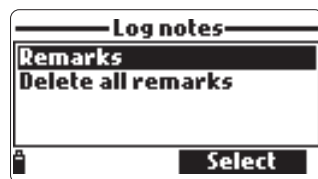

10.4.2 Delete All Remarks

- Select "Delete all remarks" to delete all remarks. The display will show the message "Do you want to perform the current operation?". Press **Yes** to delete or **No** to return to the previous screen.

Chapter 11 - PC CONNECTION MODE

The logged data from a probe or meter can be transferred to a PC using the **HI 9298194** Windows® compatible application software. **HI 9298194** offers a variety of features and on-line-help is available.

HI 9298194 allows data to be imported into most spreadsheet programs (e.g. Excel®, Lotus 1-2-3®). After the data has been imported into a spreadsheet, all features of the spreadsheet program can be used to analyze and graph the data.

11.1 SOFTWARE INSTALLATION

- Insert the installation CD into the PC.
- The software menu window should start automatically (if it does not, navigate to the main CD folder and double-click "setup.exe"). Click "Install software" and follow the instructions.

11.2 METER TO PC CONNECTION

- With the meter OFF, disconnect the probe.
- Connect the USB cable to the meter and to a USB port on the PC.
- Turn the meter ON and the message "PC connected" will be displayed.
- Run the **HI 9298194** application software.
- Press **Setting** button on the top of the screen and select the measurement units you which your data to appear with.
- To access the meter data select the "Meter" button on the toolbar at the top of the screen. The PC-Meter connection will be established and a new window will be displayed with meter data: status information (software version and date, SN, ID, battery level and free memory info), as well as a summary of logged data lots. The lots logged on the meter can be saved to the PC by pressing the "Download lot" button after the desired lot is selected.
- Once the lot has been downloaded, all the logged samples can be viewed.



- Meter to PC data
- Select parameter units
 - Select Meter from toolbar
 - Select Lot

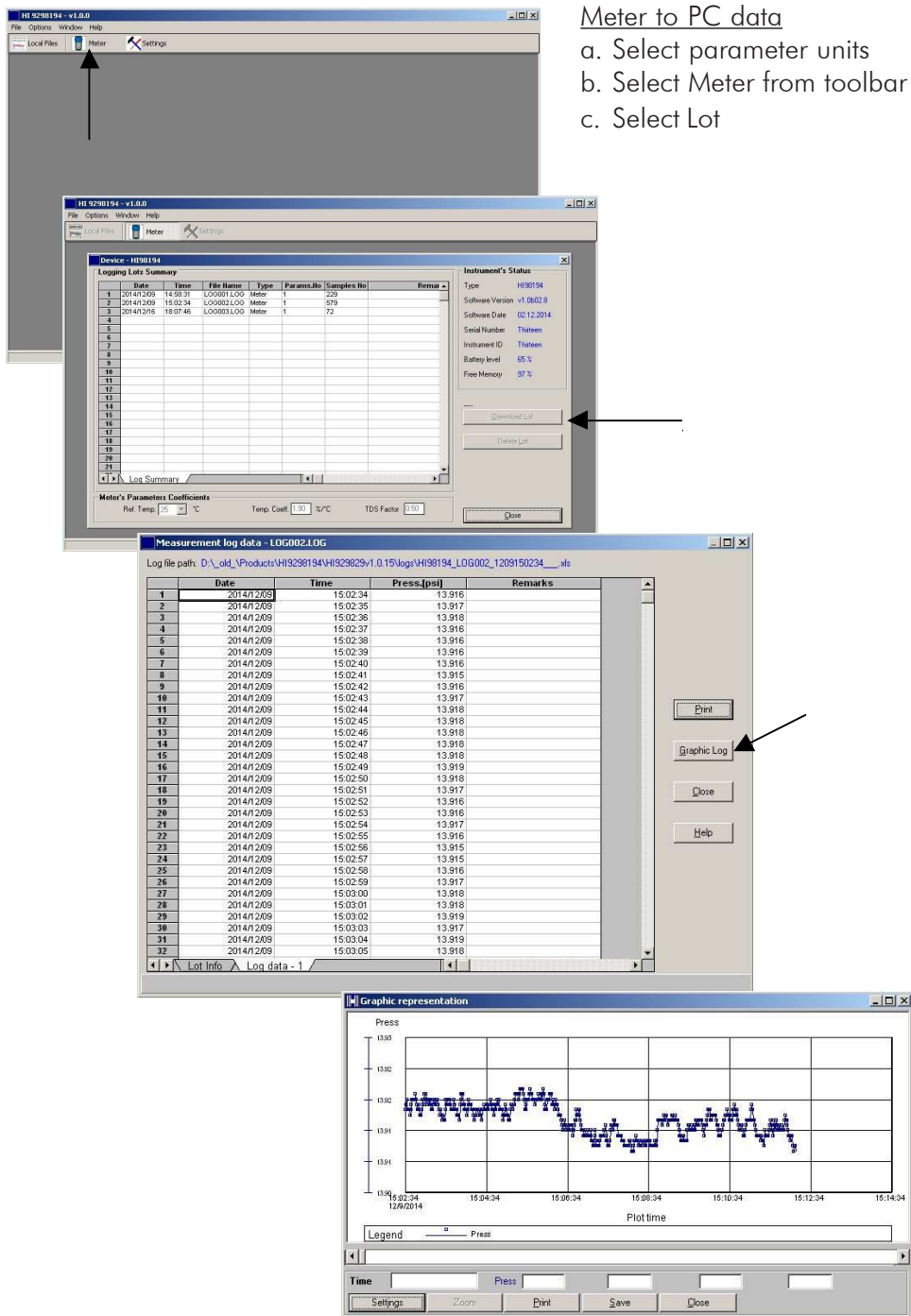

Chapter 12 - TROUBLESHOOTING / ERROR MESSAGES

HI 9819X displays error messages to aid in troubleshooting. Warnings are displayed for most issues, while Errors are displayed for critical issues.

See the calibration chapter for messages that can occur during calibration. Other messages are listed below.

- “Log space full” appears when the meter memory is full and additional data cannot be logged. Delete one or more lots from the meter (Log / Meter Log).



- “Power fault. Check the probe cable”: this message may appear when powering up the meter with a probe connected. If the meter detects a high load on the probe connection this message is triggered. Check the probe cable. If the problem persists, contact the HANNA service center.



- “Language Log data not available”: this message appears when powering up the meter if the language file is not seen by the meter. Restart the meter to verify this is a true meter error. If the problem persists, contact the HANNA service center.



- “Dead meter battery!”: This message appears if the meter batteries are too low to power the meter and it will automatically turn off. Connect the charger if using rechargeable C batteries or replace the alkaline batteries to continue.



- “User data corrupted!”: This message appears when powering up the user data stored on meter are corrupted. Restart the meter. If the problem persists, contact the HANNA service center.



- “Warning x”: Any other warning that appears at power-on is identified using a numeric code. Restart the meter. If the problem persists, contact the HANNA service center. Some meter/probe features can be accessed but with no guarantee.



- “Errors x”: Any critical errors that appear are identified using a numeric code, and the meter is automatically switched off. Contact the HANNA service center.

APPENDIX A - PROBE MAINTENANCE

The **HI 7698292** probe maintenance kit includes **HI 7042S** (electrolyte solution for D.O. sensor), spare membranes with o-rings for D.O. sensor, a small brush for cleaning EC, o-rings for sensor connectors and a syringe with grease to lubricate these o-rings.

General Maintenance

- Inspect all sensor connectors for corrosion and replace sensors if necessary.
- Inspect sensor o-rings for nicks or other damage and replace sensor if necessary. Lubricate only with grease from kit.



Use only the supplied grease as some lubricants can cause the o-rings to expand or affect the turbidity calibration standards.

- After prolonged storage or cleaning, calibration of the sensors is required.
- After use rinse the probe with tap water and dry it. The pH electrode bulb must be kept moist. Dry the D.O. and EC sensors.
- Check GLP data under “Status” to ensure the sensor is still functioning properly.

pH and pH/ORP Sensor Maintenance

- Remove the sensor protective cap. Do not be alarmed if any salt deposits are present. This is normal with pH/ORP electrodes and they will disappear when rinsed with water.
- Shake down the sensor as you would do with a clinical thermometer to eliminate any air bubbles inside the glass bulb.
- If the bulb and/or junction are dry, soak the electrode in **HI 70300** storage solution for at least one hour.
- To ensure a quick response time, the glass bulb and the junction should be kept moist and not allowed to dry. Store the sensor with a few drops of **HI 70300** storage solution or pH 4.01 buffer in the protective cap. Tap water may also be used for a very short period (few days).



Never use distilled or deionized water to store pH sensors

- Inspect the sensor for scratches or cracks. If any are present, replace the sensor.
- Cleaning procedure: clean the sensor frequently by soaking it for 1 minute in **HI 70670** or **HI 70671** cleaning solution. After cleaning soak the sensor in **HI 70300** storage solution before taking measurements.

D.O. Sensor Maintenance (only for HI 98194 and HI 98196)

For a top performance probe, it is recommended to replace the membrane every 2 months and the electrolyte monthly.

Proceed as follows:

- Unscrew the membrane by turning it counterclockwise.
- Rinse a spare membrane with some electrolyte while shaking it gently. Refill with clean electrolyte.
- Gently tap the cap over a surface to ensure that no air bubbles remain trapped. Avoid touching the membrane.
- With the sensor facing down, completely screw the cap clockwise. Some electrolyte will overflow.



If any deposit scales the sensor, gently brush the sensor surface with the supplied brush, while paying attention to not damage the plastic body. Do not use the brush on the membrane.

EC Sensor Maintenance (only for HI 98196 and HI 98195)

- After every series of measurements, rinse the probe with tap water.
- If a more thorough cleaning is required, clean the sensor with the supplied brush or a non-abrasive detergent. Ensure that the two cylindrical holes in the sensor are free of foreign material.

APPENDIX B - PROBE DEPLOYMENT

The Hanna **HI 769819X** have been designed for a variety of water quality measurements both in situ or in active deployments in urban or natural waters. The **HI 9819X** systems may be used for discrete spot sampling with a meter and the meter's log on demand function or, unattended with continuous monitoring and logging from the meter. These data are then downloaded to a meter or PC and can be plotted with logging software to obtain the graphical log needed for interpretation of the essential physical property of the aqueous body of water.

In all of these deployment situations data quality is dependent upon the site location, service intervals, amount of coatings, sedimentation and vegetation, and the actual installation. The probe may be installed in a horizontal bank (fixed installation) or a vertical suspension. The maximum depth rating of 20 m (65') for the probe should be adhered to. (Note: actual sensor specifications may be less). The location must be accessible for the duration of the measurement (consider seasonal flooding, freezing and other acts of nature) when selecting a site. Many conditions may affect the quality of measurements. Select an installation site that is representative of the water body being monitored. Avoid areas without adequate water circulation. To protect equipment it is best to avoid exposure to wind, foam, turbulence, air temperature gradients/sun, extended periods of high flow, extended periods of high sediment and floating debris. The standard operating procedures (SOP) for the data gathering must be upheld. This typically includes pre and post deployment checks of the sensors to validate data gathered between calibrations, upholding service intervals, and following any other site-specific procedures. Grab samples for laboratory analysis or spot sampling with another probe are addition ways to validate the measurements taken by unattended continuous logs.

The probe is suitable for installation in confined locations such as air vaults, river intakes, vertical wells, tanks, etc.. The streamline diameter of the probe permits insertion into 2" pipelines. Unlike probes that require a cable support for active deployments the probe can be manually lowered and raised by the cable due to it's superior strength member.

It is suitable for installation in open moving waters; rivers, streams, ditches (farmland drainage), conveyance canals, etc.. In these cases protecting the probe from debris is important. If the probe is suspended from a pier or bridge position it behind a support and anchor the cable/probe to a pipe.

It is suitable for deployment in open waters; monitoring lakes, ponds, wetland basin, infiltration basins, bays. Schedule regular service to remove aquatic weed growth that may be interfering with representative water samples.

The probe is suitable for measurements in a flow cell. Pumping water to a flow-through monitoring station has obvious pros and cons. Typically a shelter is required to secure a pump, and flow chamber. A power requirement, shelter, pump maintenance and higher installation cost need to be considered. Freeze protection, security, and convenience of calibration and possibility of adding multiple measurement points and antifouling preconditioning systems are advantages to this type of installation.

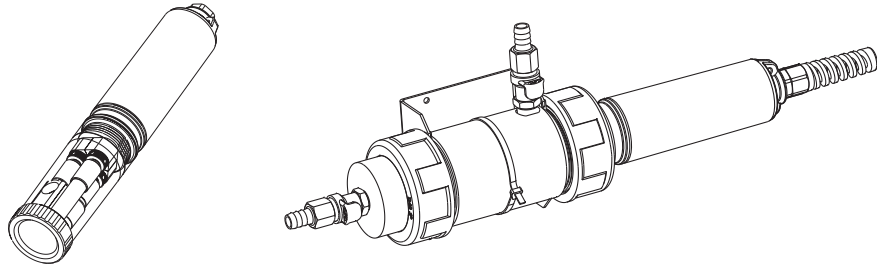

General Guidelines for fixed installation:

- Select a water-sampling site that will allow collection of representative water samples.
- Position the probe so the sensor surfaces face toward the flow. This will minimize air bubble or fluid cavitation. Limit flow rate to moderate.
- Mount Probe 0 to 45° angle from vertical to avoid sensors (pH, pH/ORP) from becoming electrically discontinuous due to internal electrolytes flowing away from their internal cells.
- Install meter and probe where they will be accessible for maintenance as required.
- Regularly visit water sampling sites to: check for damage to sensors, the installation mountings, and the meter battery power.
- Remove aquatic weed growth that may be interfering with water sample collection.
- Set up devices and programs for water monitoring and sampling.
- If the probe is suspended from a pier or bridge ensure that it is protected from debris by positioning behind a support and anchoring the cable /probe to a pipe.
- Have access to spare sensors and proper range standard solutions or buffers.
- Strictly follow the established SOP's.
- Flow cell installation; Avoid trapped air. Maintain constant flow rate.

APPENDIX C - ACCESSORIES

PROBES packed in carton box, without sensors or protective shield

HI 7698194/4	HI 7698194 probe with 4 meter (13.1') cable
HI 7698194/10	HI 7698194 probe with 10 meter (33') cable
HI 7698194/20	HI 7698194 probe with 20 meter (65.6') cable
HI 7698194/40	HI 7698194 probe with 40 meter (131.2') cable
HI 7698195/4	HI 7698195 probe with 4 meter (13.1') cable
HI 7698195/10	HI 7698195 probe with 10 meter (33') cable
HI 7698195/20	HI 7698195 probe with 20 meter (65.6') cable
HI 7698195/40	HI 7698195 probe with 40 meter (131.2') cable
HI 7698196/4	HI 7698196 probe with 4 meter (13.1') cable
HI 7698196/10	HI 7698196 probe with 10 meter (33') cable
HI 7698196/20	HI 7698196 probe with 20 meter (65.6') cable
HI 7698196/40	HI 7698196 probe with 40 meter (131.2') cable

- Note:**
- Probes with different cable length are available upon request.
 - Order protective shields separately.

METERS WITH PROBES (packaged together in a sturdy carrying case with probe maintenance kit, HI 9298194 PC Application Software, HI 7698290 calibration beaker, HI 9828-20 calibration solution (230 mL), USB cable, Manual, appropriate probe shield and specified sensors)

- HI 98194** **HI 98194** meter, probe with 4 meter (13.1') cable, with pH/ORP, EC, D.O. sensors.
- HI 98194/10** **HI 98194** meter, probe with 10 meter (33') cable, with pH/ORP, EC, D.O. sensors.
- HI 98194/20** **HI 98194** meter, probe with 20 meter (65.6') cable, with pH/ORP, EC, D.O. sensors.
- HI 98194/40** **HI 98194** meter, probe with 40 meter (131.2') cable, with pH/ORP, EC, D.O. sensors.
- HI 98195** **HI 98195** meter, probe with 4 meter (13.1') cable, with pH/ORP, EC sensors.
- HI 98195/10** **HI 98195** meter, probe with 10 meter (33') cable, with pH/ORP, EC sensors.
- HI 98195/20** **HI 98195** meter, probe with 20 meter (65.6') cable, with pH/ORP, EC sensors.
- HI 98195/40** **HI 98195** meter, probe with 40 meter (131.2') cable, with pH/ORP, EC sensors.
- HI 98196** **HI 98196** meter, probe with 4 meter (13.1') cable, with pH/ORP, D.O. sensors.
- HI 98196/10** **HI 98196** meter, probe with 10 meter (33') cable, with pH/ORP, D.O. sensors.
- HI 98196/20** **HI 98196** meter, probe with 20 meter (65.6') cable, with pH/ORP, D.O. sensors.
- HI 98196/40** **HI 98196** meter, probe with 40 meter (131.2') cable, with pH/ORP, D.O. sensors.

SENSORS

- HI 7698194-0** pH sensor
- HI 7698194-1** pH/ORP sensor
- HI 7698194-2** Dissolved Oxygen sensor
- HI 7698194-3** EC sensor

CABLES, CONNECTORS, ACCESSORIES

- HI 7698290** Short calibration beaker
- HI 7698295** Short protective shield
- HI 7698297** Long, quick release flow cell
- HI 7698292** Probe maintenance kit with **HI 7042S** (electrolyte solution for D.O. sensor), small brush, small hex key, O-rings for D.O. sensor (5 pcs.), O-rings for probe (5 pcs.) and syringe with grease to lubricate the O-rings
- HI 76981952** Probe maintenance kit with small brush, small hex key, O-rings for probe (5 pcs.) and syringe with grease to lubricate the O-rings.
- HI 9298194** PC application software
- HI 920015** Micro USB cable, PC to meter

QUICK CALIBRATION SOLUTIONS

HI 9828-20	Quick calibration solution, 230 mL
HI 9828-25	Quick calibration solution, 500 mL
HI 9828-27	Quick calibration solution, 1 gal.

pH BUFFERS

HI 5004	pH 4.01 buffer solution, 500 mL
HI 5046	pH 4.63 buffer solution, 500 mL
HI 5005	pH 5.00 buffer solution, 500 mL
HI 5006	pH 6.00 buffer solution, 500 mL
HI 5068	pH 6.86 buffer solution, 500 mL
HI 5007	pH 7.01 buffer solution, 500 mL
HI 5074	pH 7.41 buffer solution, 500 mL
HI 5008	pH 8.00 buffer solution, 500 mL
HI 5009	pH 9.00 buffer solution, 500 mL
HI 5091	pH 9.18 buffer solution, 500 mL
HI 5010	pH 10.01 buffer solution, 500 mL

ORP SOLUTIONS

HI 7020L	ORP test solution, 200/275 mV @ 20 °C, 500 mL
HI 7021L	ORP test solution, 240 mV @ 20 °C, 500 mL
HI 7022L	ORP test solution, 470 mV @ 20 °C, 500 mL
HI 7091L	Reducing pretreatment solution, 500 mL
HI 7092L	Oxidizing pretreatment solution, 500 mL

pH/ORP MAINTENANCE SOLUTIONS

HI 70670L	pH/ORP cleaning solution for salt deposits, 500 mL
HI 70671L	pH/ORP cleaning and disinfecting solution for algae, fungi and bacteria, 500 mL
HI 70300L	pH/ORP electrode storage solution, 500 mL

DO SOLUTIONS

HI 7040L	Zero oxygen solution, 500 mL
HI 7042S	Electrolyte solution for D.O. sensor, 30 mL
HI 76409A/P	Spare membrane with O-ring (5 pcs.)

CONDUCTIVITY STANDARD SOLUTIONS

HI 7030L	12880 $\mu\text{S}/\text{cm}$ calibration solution, 500 mL
HI 7031L	1413 $\mu\text{S}/\text{cm}$ calibration solution, 500 mL
HI 7033L	84 $\mu\text{S}/\text{cm}$ calibration solution, 500 mL
HI 7034L	80000 $\mu\text{S}/\text{cm}$ calibration solution, 500 mL
HI 7035L	111800 $\mu\text{S}/\text{cm}$ calibration solution, 500 mL
HI 7039L	5000 $\mu\text{S}/\text{cm}$ calibration solution, 500 mL

APPENDIX D - WARRANTY

All HANNA Instruments® meters are guaranteed for two years (sensors, electrodes and probes for six months) against defects in workmanship and materials when used for their intended purpose and maintained according to instructions.

This warranty is limited to repair or replacement free of charge. Damages due to accidents, misuse, tampering or lack of prescribed maintenance are not covered.

If service is required, contact the dealer from whom you purchased the instrument. If under warranty, report the model number, date of purchase, serial number and the nature of the problem.

If the repair is not covered by the warranty, you will be notified of the charges incurred.

If the instrument is to be returned to HANNA Instruments®, first obtain a Returned Goods Authorization number from the Technical Service department and then send it with shipping costs prepaid.

When shipping any instrument, make sure it is properly packed for complete protection.

Recommendations for Users

Before using this product, make sure that it is entirely suitable for the environment in which it is used. Operation of this instrument in residential areas could cause unacceptable interferences to radio and TV equipment, requiring the operator to take all necessary steps to correct interferences. The glass bulb at the end of the electrode is sensitive to electrostatic discharges. Avoid touching this glass bulb at all time. To maintain the EMC performance of equipment, the recommended cables noted in the instruction manual must be used. Any variation introduced by the user to the supplied equipment may degrade the instruments' EMC performance. To avoid electrical shock, do not use this instrument when voltage at the measurement surface exceed 24 Vac or 60 Vdc. To avoid damage or burns, do not perform any measurement in microwave ovens.



Hanna Instruments Inc.
Highland Industrial Park
584 Park East Drive
Woonsocket, RI 02895 USA

Technical Support for Customers

Tel. (800) 426 6287
Fax (401) 765 7575
E-mail tech@hannainst.com
www.hannainst.com

Local Sales and Customer Service Office

