



GasCheck G 1, 2 and 3 (Graphical) User Manual V1.8



Declaration of Conformity

Manufacturer: Ion Science Ltd, The Way, Fowlmere, Cambridge, England. SG8 7UJ

Product: GasCheck G 1, 2 and 3 (Graphical)

Product description: a handheld micro thermal conductivity sensor used to detect gas leaks. This instrument has been designed specifically for search and location of non-flammable gases such as helium and CFC's.

Directives: 2004/108/EC

Electrical Equipment – Electromagnetic Compatibility (EMC)

Standards: BS EN 61010-1:2001

Safety requirements for electrical equipment for measurement, Control and laboratory use – Part 1: General requirements

BS EN ISO 9001:2000

Quality management systems – Requirements

BS EN 61326-1:2006

Electrical Equipment for measurement, control and laboratory use - EMC Requirements (Class B and General Immunity)

I the undersigned hereby declare that the equipment specified above conforms to the stated Directives and Standards.

Signed By:



Name: Mark Stockdale,

Position: Technical Director

Date: 30th October 2008

Menu

	Page
Declaration of conformity	2
Menu	3
Statements	4
Instrument description	5
Packing list	6
How GasCheck G works	7
Instrument Main Menu	8
Running screen	9
Functions	10
Getting started	13
Using GasCheck G	14
Probe options	15
Detecting leaks	16
Calibration	17
Replacing batteries	19
Instrument specification	20
Replacement parts	20

Statements

Safety

Please read this manual in full before using the GasCheck G instrument. Ion Science Ltd takes no responsibility for damage, injury or death resulting from misuse, misunderstanding or negligence while using this gas detector. Please contact Ion Science Limited via the address below for clarification on any aspect of this manual that is not understood or for additional information required.

This instrument should only be used by qualified or competent persons with suitable knowledge of the hazards relating to the gases contained within equipment or in the local environment.

Quality Assurance

GasCheck G instruments are manufactured in compliance with ISO9001:2000, which ensures that the equipment supplied to the customer has been designed and assembled reproducibly from traceable components, leaving Ion Science calibrated to traceable standards.

Responsibility of use

Many gases are hazardous and can cause explosion, poisoning and corrosion resulting in damage to property and life. It is the responsibility of the person using this instrument to ensure it is being used in accordance with this manual and that the instrument is functioning correctly before use.

The GasCheck G can detect a large range of gases but some gases are more difficult to detect.

It is the responsibility of the user to ensure the GasCheck G instrument has the sensitivity to detect the required gas before reaching potentially dangerous levels.

Disposal

Disposal of GasCheck G, its components and any used batteries shall be in accordance with local and national safety and environmental requirements. This includes the European WEEE (Waste Electrical and Electronic Equipment) directive. Ion Science Ltd offers a 'take-back' service. Please contact Ion Science Ltd for more information.

Calibration Facility

Ion Science Ltd offers a calibration service including the issue of certification confirming calibration with equipment traceable to UKAS standards.

A GasCheck G Calibration Kit offers a means of checking and calibrating the instruments against a known reference, however Ion Science Ltd strongly recommend the instrument is returned to an approved service centre on an annual basis for general maintenance and calibration.

Contact Ion Science Ltd

Postal address: Ion Science Ltd
The Way
Fowlmere
Cambridge
SG8 7UJ
UK

By Telephone: +44 (0) 1763 208503

By Fax: +44 (0) 1763 208814

By Email: info@ionscience.com

Instrument Description

The GasCheck G is a range of portable hand held gas detector instruments predominantly used for detecting gas leaks and can detect almost all gases to varying degrees. Being a hand held instrument it is powered by standard AA size batteries and will accept both Alkaline and Nickel Metal Hydride (rechargeable) types.

The GasCheck G uses thermal conductivity as it's means of detecting gas which offers a robust sensor technology that requires practically no maintenance beyond annual servicing.

All GasCheck G models have an easy to use graphical interface with an intuitive keypad allowing simple function selection and adjustment.

The GasCheck G is a range of instruments that can be upgraded to add features without the need to be returned to the supplier and without having to modify the internal firmware.

GasCheck G has an LCD display, LED indicator and audible sounder that indicates the detected signal.

Common applications where The GasCheck G is already used include:

- * Quality assurance - Testing seal integrity after product manufacture
- * Laboratory applications - Detection of leaks from mass spectrometers and chromatograph equipment
- * Industrial - Leaks from gas cylinders, pipe work and process equipment
- * Medical - Testing of membrane materials and sealing of glove boxes
- * Pneumatic - Valve seal testing

The GasCheck G is calibrated against a 5 E-4 cc/s Helium leak to allow volumetric readings and also a 5000ppm Helium to allow measurement of concentrations.

Selectable units:

cc/sec	Cubic Centimetres per Second offers a reading that indicates the volume of gas escaping into atmosphere from a single point. ie. leakage from a hole in a gas filled vessel or pipe.
ppm	Parts Per Million is a concentration reading, GasCheck G will display the concentration being detected however it is more difficult to gauge the quantity of leakage.
mg/m ³	Milligrams per meter cubed is also a unit that measures concentration. (See ppm above)
g/yr	Grams per Year is an alternative measure of leak rate.

IMPORTANT NOTES:

The GasCheck G range is NOT intrinsically safe so should not be using in a potentially explosive environment. Intrinsically safe GasCheck instruments are available, please contact Ion Science Ltd for more information.

Ambient air pressure, heat and humidity can also affect readings.

The GasCheck G range is NOT 'Gas Specific' i.e. It can NOT differentiate between gases.

Packing list

Please remove all packing material and then check the content of the carry case against the list below before use. Should the instrument or any accessory appear damaged or missing then contact the instrument supplier for advise before use.

Item	Qty	Description	Check
1	1	GasCheck G instrument with short probe and nozzle fitted	
2	1	Long probe	
3	1	Box spanner used to change probes	
4	1	Spare battery clip	
5	1	User manual	
6	1	Calibration certificate	
7	1	CD containing additional product information	



How GasCheck G works

Thermal Conductivity

All gases conduct heat but by varying amounts, if an object is heated and then the source of heat is removed, the object will eventually cool down to match ambient air temperature. This action occurs because the ambient air surrounding the object carries the excess heat into the surrounding atmosphere.

This principle is also the same for objects that are cooler than the surrounding ambient air.

Dissipation of heat into an air atmosphere is known and is a predictable rate however, if the ambient air is replaced with an alternative gas like Helium the rate at which an object cools down changes.

If the object mentioned above had its environment replaced with pure Helium it would cool down to the environment temperature about 6 times faster.

The GasCheck G contains a heated thermistor bead that transmits heat to a block of material that remains at a constant temperature. As air passes through the detector chamber a constant amount of heat passes from the bead to the block. Gases that are different to air will affect the rate at which heat transmits from the bead to the block, these rates of change are measured and displayed as leak rates.

The diagram below shows the basic functionality of the GasCheck G's Thermal Conductivity sensor. A fan draws a small flow of gas through the probe and into the sensing chamber. The thermistor bead heats up when electrical power is applied. As air passes through the cell a constant level of heat is transmitted to a Temperature Stable block through the air, this rate of heat transmission is used to 'Zero' the instrument.

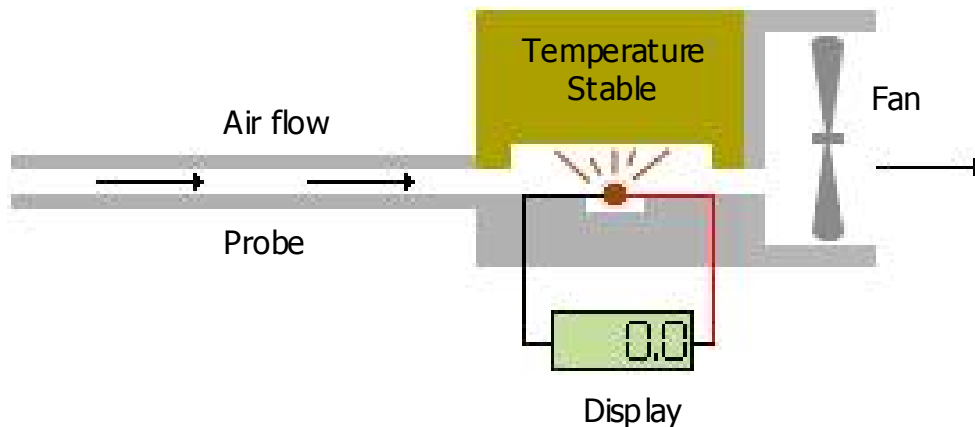

When gases with different thermal qualities pass through the chamber the amount of heat being transmitted to the Temperature Stable block changes. These changes are measured, calculated and displayed on GasCheck G as leak rates or gas concentrations.

PLEASE NOTE:

* Some gases have similar thermal properties to that of air, therefore the GasCheck G can only detect larger concentrations of these gases.

* Some gases have positive and other gases negative signals. To simplify the instrument's function GasCheck G only displays changes as positive readings.

* The GasCheck G can NOT differentiate between gases! Selecting a specific gas on the GasCheck G allows the instrument to calculate concentrations of that gas only if that gas is being detected.

Instrument Main Menu

Once the GasCheck G has run through its 'Start up' routine it will display its normal 'Running screen' used when locating gas leaks. Before using the instrument the various settings should be set and adjusted to suit the application.

Pressing the 'Esc' key while viewing this 'Running screen' will access the instruments Main Menu. Repeated pressing of the 'Esc' returns back to the 'Running screen'.



Running screen

PLEASE NOTE:

The amount of functionality varies between models. The 'Function' section (Pages 10 to 12) of this manual indicates which functions relate to which model.

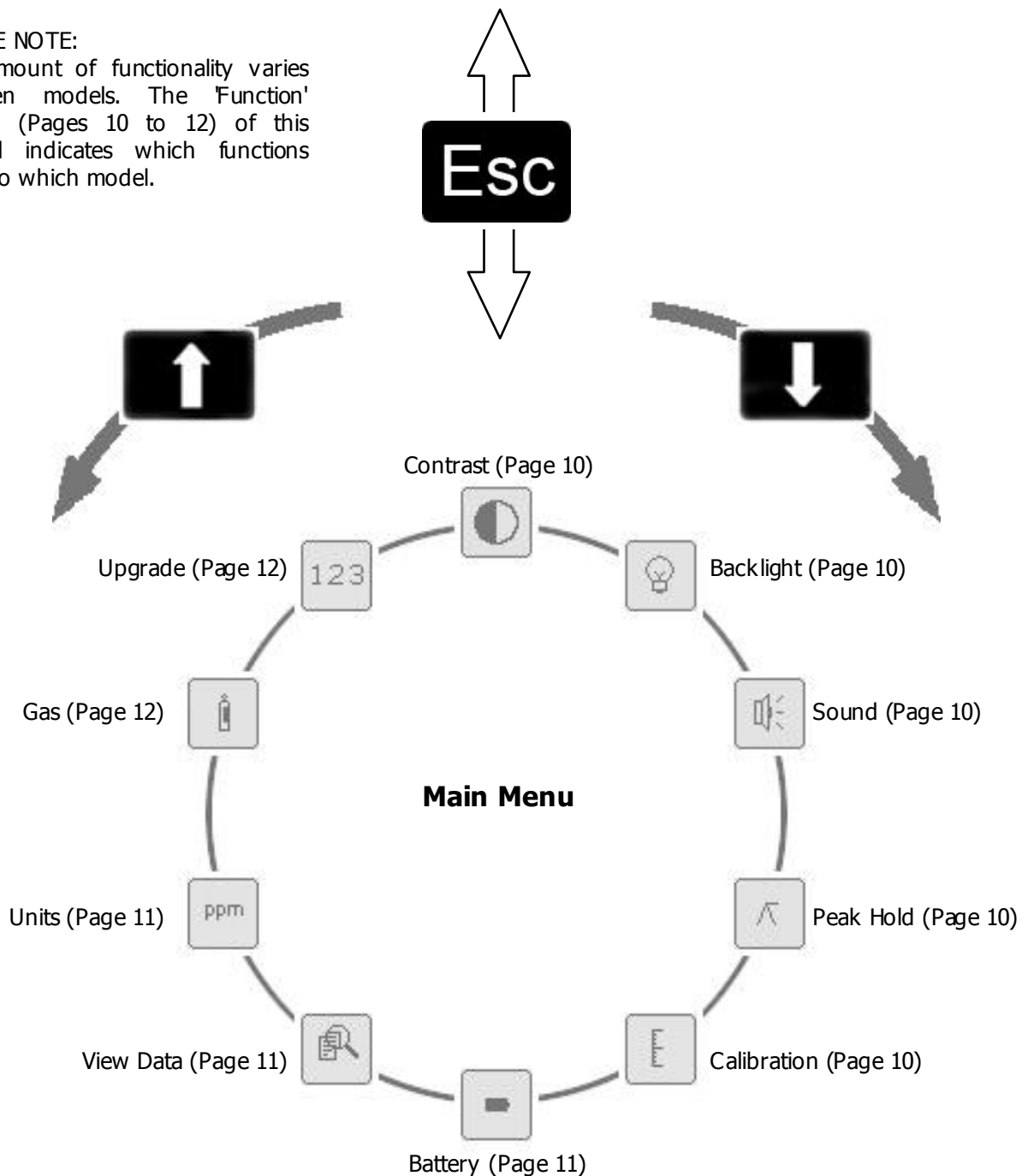

Running screen

GasCheck G displays the 'Running screen' when ever the instrument is being used to detect leaking gas, the illustration below outlines the various information and icons.

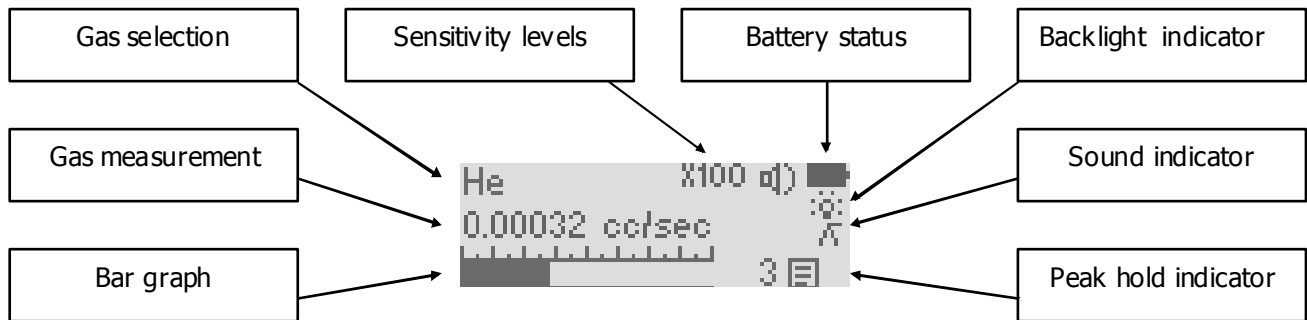

Gas selection

The GasCheck G2 and G3 display the gas being measured in the top left of the running screen. The GasCheck G2 will display the gas selected at the factory only however the G3 model has a range of gases that can be selected via an internal gas table.

Sensitivity

GasCheck G has three (3) sensitivity levels, X100 (times one hundred) is most sensitive, X10 (times ten) is mid range and X1 (times one) is least sensitive. See the sensitivity of various gases on the table on page 12 regarding Gas Selection.

Battery status

When the battery symbol is filled in the battery is full, when just an outline the battery is exhausted

Backlight

The backlight symbol shows the status of the backlight even in bright daylight.

Gas measurement

The GasCheck G2 and G3 measure the leak rate of gas leakage in which ever units are selected.

Sound indication

This symbol shows if the sounder is on or off, if the semi circle (on the right) of the symbol is present then the sound is switched on, if not the sounder is switched off. The beep that occurs with each key press can not be switched off.

Bar graph

The bar graph increases as gas is detected. This graph is not scaled and should be used for indication only. The GasCheck G1 has no measured units so relies on this bar graph to indicate leakage, when gas is detected and the bar graph has reached it's maximum level, a different sensitivity level can be selected to give a wider detection range.

Peak hold

When selected, peak hold displays the maximum measurement on the display. Press the ENTER key resets the reading but also logs the peak reading in memory.

Functions

The GasCheck G instruments have a variation of functionality, each of the functions listed below has number to the right of the heading that indicates which function is included within each model:-

GasCheck G1 = **1**, GasCheck G2 = **2**, GasCheck G3 = **3**.

Contrast

1, 2 & 3

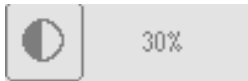

Use this function to adjust the contrast of the GasCheck G' LCD (Liquid Crystal Display). Significant variations in ambient temperature conditions can cause the display to appear too dark or faint.

When this function is selected a number will appear to the right of the Contrast symbol as a percentage, use the Up and Down keys to adjust the display contrast to the desired level. When satisfied with the desired level selected, press the Esc key to exit to the main menu.

Backlight

1, 2 & 3



The user can select either Backlight On or Backlight Off.

In daylight the user may not be able to determine if the backlight is On or Off therefore a symbol on the main running screen shows the status.

When the backlight is 'ON' it significantly reduces battery life.

Backlight OFF = 40hrs of use, Backlight ON = 20hrs of use.

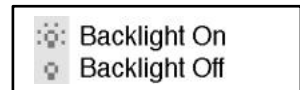

Sound

1, 2 & 3



The GasCheck G has an audible sounder that increases frequency as detected gas levels increase. This sounder can be switched On and Off. Use the Up or Down key to move the 'tick' to the desired position and then press the 'Esc' key to return to the Main Menu.

An audible 'beep' can also be heard when ever the key pad is pressed, this beep can not be switched off.

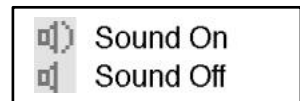

Peak hold

2 & 3



When selected, this function holds the highest detected reading on the display until the 'ENTER' key is pressed.

Select Peak On or Off using the 'Up or Down' key and then press 'Esc' key to exit to the 'Main menu'.

When using the GasCheck G, press the ENTER key to clear the held reading.

The reading held on screen will be logged when the 'ENTER' key is pressed.

WARNING: ZEROing the instrument in a contaminated environment will result in false readings.

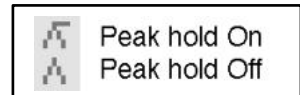

Calibration

2 & 3



There are two Calibration settings that can be selected; Factory and Custom. Factory calibration is carried out shortly after manufacture and cannot be adjusted, however Custom calibration offers the ability to calibrate the instrument between annual Factory calibrations. The GasCheck G Zero's its reading at switch on, therefore the Custom calibration routine only has one stage.

Also see the Calibration section of this manual on Page 16



Functions (continued)

Battery selection



The GasCheck G will operate using AA size batteries in either Alkaline (non rechargeable) or Nickel Metal Hydride (Rechargeable). Select the battery type using the 'Up or Down' key and then press the 'Esc' key to exit to the Main menu.

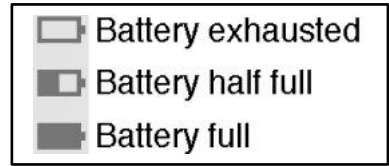

3

Failing to select the correct battery type will not damage the instrument or affect it's ability to detect gas, however it will cause the battery indicator to read incorrectly.

View Data



The GasCheck G instrument has the ability to data log 10 readings within its internal memory. To store a reading press the 'ENTER' key while on the main Running screen. When readings are stored in memory a symbol will appear on the Main viewing screen.

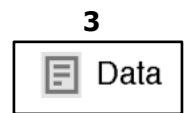

3

When the memory is full the 'Data' symbol will flash. The stored data can be viewed buy scrolling through the logged readings using the 'Up and Down' keys. To delete the stored data press and hold the 'ENTER' key, the 'Trash can' symbol will flash, continue holding the 'ENTER' key until the data is deleted. Press the 'Esc' key to exit to the Main menu.

Units



GasCheck G instruments have the capability of displaying detected readings in a variation of units; ppm, cc/s, mg/m³ and g/yr.

3

Use the 'Up and Down' keys to select the desired unit and then press the 'Esc' key to exit to the main menu.

Please note: the Custom Calibration routine automatically selects the type a calibration depending on this setting. See the Calibration section of this manual on page 16

cc/sec = Cubic Centimetres per second offers a volumetric leak rate that directly measures the volume of a gas escaping from a given point, it is also known as ml/sec (Millilitres per second). The GasCheck can typically detect Helium leaks down to 0.0005 of a cubic centimetre per second.

ppm = Parts per million, this unit indicates a concentration but can't be used to quantify a volume of gas leakage.

mg/m³ = Milligrams per meter cubed, like ppm this unit is also concentration so can't be used to quantify a volume of gas leakage.

g/yr = Grams per year offers an alternative volumetric leak rate that directly measures the volume of a gas escaping from a given point.

Display

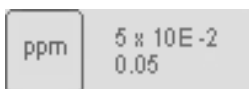

GasCheck G instruments have the capability of displaying cc/sec and g/yr readings in either decimal or exponent form. (Readings in ppm and mg/m³ can only be displayed in decimal form.)

3

Use the 'Up and Down' keys to select the desired unit. Press the 'Enter' key to display the next screen. Use the 'Up and Down' keys to select the desired display and then press the 'Esc' key twice to exit to the main menu.

Functions (continued)

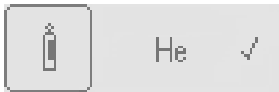

Gas selection

3

GasCheck G is calibrated using Helium gas at manufacture, however other gases can be detected and measured using a gas table within the instrument.

Although GasCheck G can't differentiate between gases it can quantify other gases using response factors stored in its internal gas table. Gas groups 0, 1 2, 3, and 4 offer a generic sensitivity.

The following list indicates response factors for specific gases however for advice on gases not listed please contact Ion Science Ltd for advice.

Name	Abbreviation	Minimum sensitivity cc/sec (ml/sec)	Minimum sensitivity cc/sec (ml/sec)
Hydrogen	H2	7.7 E-6 cc/sec	0.000077 cc/sec
Helium	He	1.0 E-5 cc/sec	0.000010 cc/sec
Refrigerant R12	R12	2.7 E-5 cc/sec	0.000027 cc/sec
Refrigerant R1301	R1301	2.4 E-5 cc/sec	0.000024 cc/sec
Refrigerant R134a	R134a	5.8 E-5 cc/sec	0.000058 cc/sec
Refrigerant R22	R22	2.6 E-5 cc/sec	0.000026 cc/sec
Refrigerant R11	R11	3.2 E-5 cc/sec	0.000032 cc/sec
Sulphur Hexafluoride	SF6	2.2 E-5 cc/sec	0.000022 cc/sec
Carbon dioxide	CO2	4.0 E-5 cc/sec	0.000040 cc/sec
Methane	CH4	2.9 E-5 cc/sec	0.000029 cc/sec
Argon	Ar	3.5 E-5 cc/sec	0.000035 cc/sec
Oxygen	O2	2.9 E-4 cc/sec	0.000290 cc/sec
Refrigerant R502	R502	3.0 E-5 cc/sec	0.000030 cc/sec
Refrigerant R404a	R404a	3.2 E-5 cc/sec	0.000032 cc/sec
Refrigerant R407c	R407c	3.3 E-5 cc/sec	0.000033 cc/sec
Refrigerant R410a	R410a	3.2 E-5 cc/sec	0.000032 cc/sec
Refrigerant R507	R507	3.8 E-5 cc/sec	0.000038 cc/sec

To select an alternative gas use the 'Up and Down' keys to select the desired gas and then press the 'ENTER' key to confirm the selection, at which point a tick will appear. Press the 'ENTER or Esc' key to exit into the 'Main menu'.

If the gas to be detected does not appear in the instruments internal gas table then one of the five 'Gas Groups' can be selected. 'Gas Groups' have a variation of sensitivities. (Group 1 being high sensitivity through to Group 5 being low sensitivity) Contact Ion Science Ltd for advice.

Gas groups allow the instrument to calculate leak rates with reasonable accuracy.



Upgrade

1 & 2

The GasCheck G instrument can be upgraded using a simple upgrade code.

This facility allows GasCheck G to be upgraded instantly by the user in the field.

The table below shows the various features within each model

GasCheck G model	Contrast	Backlight	Sound	Peak hold	Custom Calibration	Battery Type	Data log	Measurement Units	Gas table	Upgrade
G1	✓	✓	✓							✓
G2	✓	✓	✓	✓	✓					✓
G3	✓	✓	✓	✓	✓	✓	✓	✓	✓	

To upgrade a GasCheck G simply purchase an upgrade code from Ion Science Ltd, enter the 12 digit number in the upgrade screen using the UP, DOWN, ENTER and Esc keys. Once all 12 digits are entered correctly the instrument will automatically switch off.

When the instrument is switched on the new instrument model number will be displayed.

Getting Started

The Keypad

All GasCheck G models have the same keypads, the following section explains the general functionality of each key:-

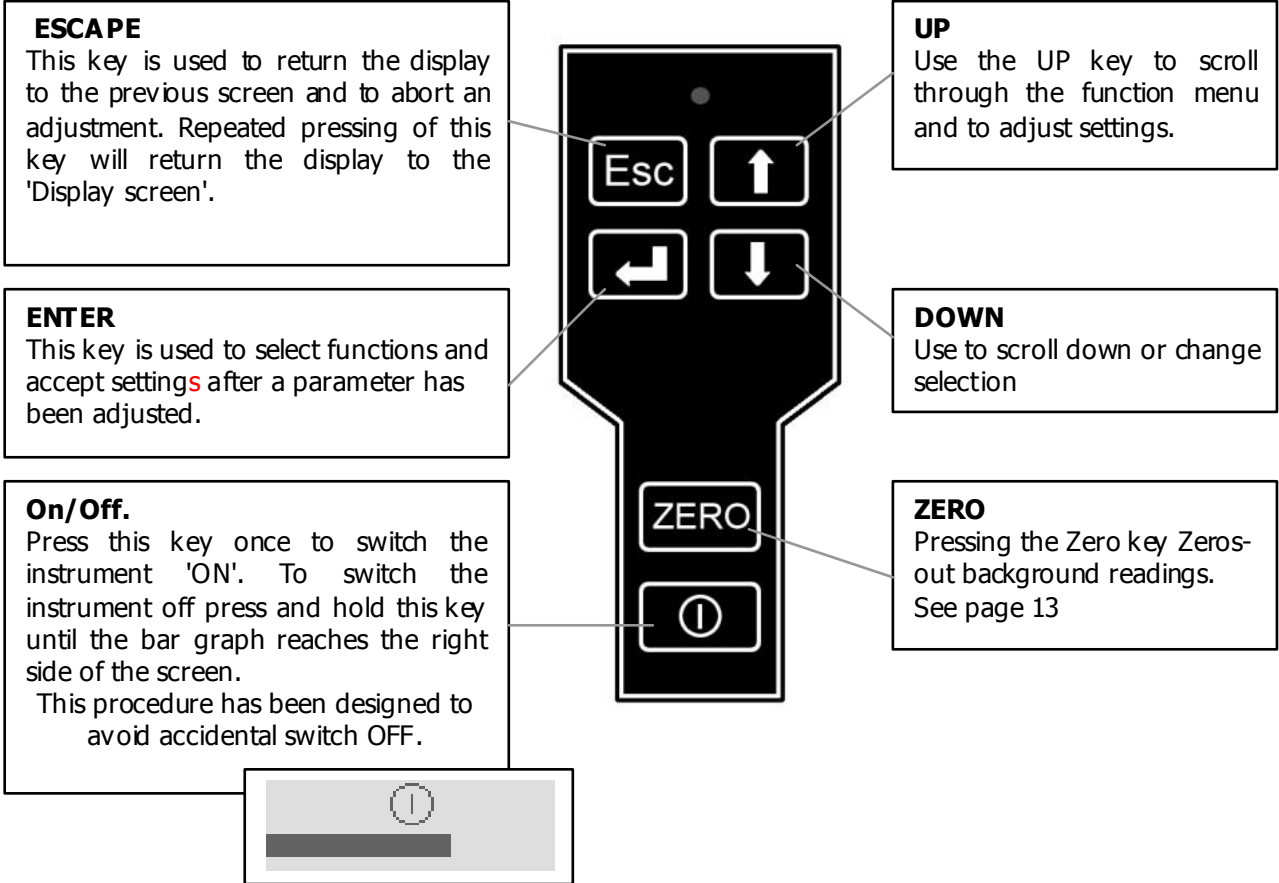

When the GasCheck G first switches on it will display its model number and the Gas that it has been calibrated with.



A second screen then displays the instrument's serial number, the instrument's firmware version and Ion Science web address.

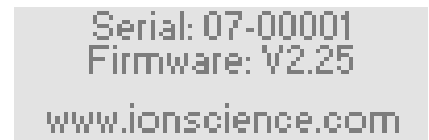

A third screen appears to indicate the GasCheck G is Zeroing it's signal.

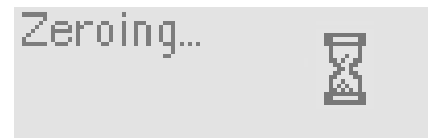

Once the Zero routine is complete the instrument displays it's running screen and is ready for use.

Using GasCheck G

The GasCheck G instrument

WARNING: Before switching the GasCheck G on, ensure the ambient air is clean as the instrument automatically Zero's the sensor at switch on. After the instrument has run through its start up routine, adjust the instrument settings to the desired levels. Check the instruments sensitivity using a CalCheck or calibration kit

Switch the GasCheck G on by pressing the ON/OFF key, after the instrument has completed its Zero routine it will enter it's normal running screen. (see right)



Ensure the instrument is on the X100 (times one hundred) range, while on the main running screen use the UP and DOWN key to adjust between sensitivity ranges. X100 is most sensitive, X1 is the least sensitive.

Gas leaks tend to occur at pneumatic joints or welded seams, hold the GasCheck G at a 45° angle to the object being tested and drag the probe along the seam or joint at a rate of approximately 25mm per second.

When a leak is detected the bar graph will start to fill and the frequency of the audio output will increase but will reduce as the probe moves away from the leak. Return the probe to the suspected leaking area and move slowly along the same area until the leak is located, once located the probe should be held at the leak until the numeric reading stabilizes.

The bar graph offers a graphical indication only and should not be used to measure a leak, you may find that the graph completely fills however the numeric reading will continue to increase. Should the instrument detect a leak that is too large for the range selected the numeric screen will flash and display '99999', use the UP or DOWN keys to adjust the instrument sensitivity.

Variation in temperature, humidity and background gas may result in a constant level being detected on the instrument. To reset to Zero, hold the instrument away from the source of contamination and then press the ZERO key. The instruments display will return to a near zero reading.

The following things will affect the instruments reading:-

- * Breath of the instrument user contains both CO₂ and moisture;
- * Barometric air pressure and background temperature;
- * Sources of cold and heat.

Probe Options

In some applications the grey probe cover may restrict access to the area under test, the grey probe cover can be removed by pulling it off way from the instrument ❶. When the grey cover is removed great care should be taken when using the instrument and the following precautions noted:-

- * Do not remove the semi transparent probe sleeve, this sleeve ensure the metal inner probe remains 1 mm from the surface of the test area avoiding accidental dirt and moisture ingress.
- * Do not touch the probe and especially the brass sensor housing. Heat from fingers can result in significant changes in signal causing false readings.
- * Avoid placing the probe on wet or dirty surfaces, blockage of the probe will result in instrument failure.

Some application may require a longer probe to gain access to pneumatic joints and seams to be tested, the GasCheck G is also supplied with a 300mm probe that can be changed by the user. To change probes carefully follow the following steps:-

- * Switch the instrument OFF
- * Remove the outer grey probe cover ❶
- * Place the box spanner (supplied with the instrument) over the existing probe so the spanner fits over the brass nut ❷, unscrew the probe counter-clockwise direction. ❸
- * Withdraw the spanner and probe assembly ❹

To refit the short or the long probe follow the steps above but in reverse order.

CAUTION: When using the box spanner to tighten the probe nut, ensure the nut is firmly tightened however do not use additional tools as the tread may become damaged.

Should a probe become blocked, use dry, clean compressed air to blow out the blockage from the instrument end of the probe.

WARNING: Ensure safety guidelines are adhered to when using compressed air.
(Ion Science Ltd takes no responsibility for injury or damage caused by misuse of compressed air equipment)

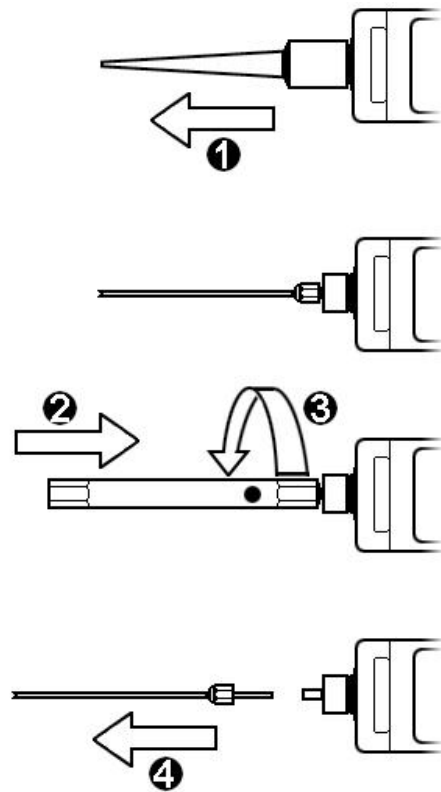

Detecting leaks

Over view

Hold the GasCheck G in one hand and draw the instrument probe along the area to be checked at approximately 25mm per second. When a leak is detected retrace the route of the probe at a slower rate until the leak is located. Once located hold the instrument over the leak until the measurement stabilises. The reading can be logged by pressing the ENTER key.

Some readings may be larger than the instrument can detect and the measurement units will be replaced by '99999' on the display, in which case use the UP or DOWN keys to adjust the instrument's sensitivity.

When detecting very small leaks or when detecting gasses less sensitive than a rate of 10mm per second may be required.

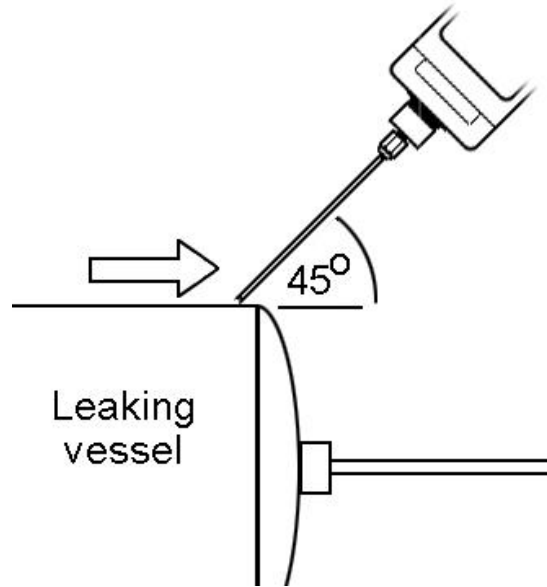

The outer grey probe cover can be removed to allow better access to restricted areas, if the outer probe is removed the following points should be noted:-

- * Avoid bending the inner probe as this will affect the GasCheck G's accuracy.
- * Avoid placing the probe in liquid or dirt as the probe can become blocked.
- * Care should also be taken to ensure the brass sensor housing component remains at a constant temperature. Avoid touching the brass sensor block with fingers.
- * GasCheck G can detect changes in Humidity and Carbon dioxide, therefore avoid breathing on the probe.
- * The thin white tube that covers the inner probe should not be removed, this tube ensures a 1mm gap is maintained between the probe and the surface being tested.

Calibration

Over view

The GasCheck G has two selectable calibration settings; Factory and Custom. 'Factory Calibration' is carried out at Ion Science Ltd/ Authorised Service Centres during the instruments manufacture, it can be selected and used but can not be changed.

The GasCheck G is calibrated against a 5000 ppm Helium concentration and a 0.0005cc/sec (5 E-4) Helium leak rate.

'Custom Calibration' gives the user the ability to calibrate the instrument, this facility may offer improved accuracy over the 'Factory Calibration' if the Barometric air pressure differs from that stated on the instruments Calibration certificate.

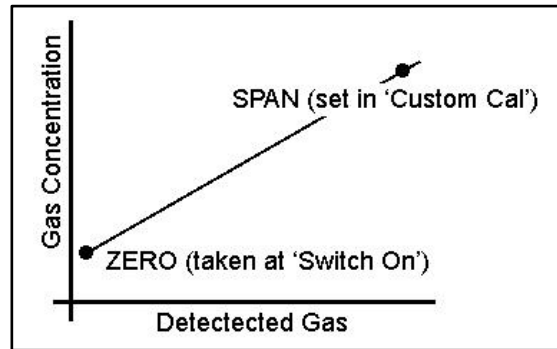

Selecting Factory or Custom Calibration

To select either Factory or Custom Calibration select the Calibration screen and use the UP and DOWN keys to move the 'tick / check' under the desired symbol, then Press the 'Esc' key to exit into the main menu.



'Custom Calibration' can only be selected and used after the instrument has been calibrated by the user, to do this move the 'tick / check' under the 'Custom Cal' symbol and press the ENTER key.

The GasCheck G requires either 5000 ppm Helium concentration or a 0.0005cc/sec (5 E-4 cc/sec) leak rate as a reference. The GasCheck G automatically selects the type of Calibration media based on which units the instrument already has selected.

If the GasCheck G is used to detect leaks measured using 'ppm or mg/m³' units then the instrument must be calibrated using a 5000 ppm Helium concentration.

If the GasCheck G is used to detect leaks measured using 'cc/sec' units then the instrument must be calibrated using a 0.0005 cc/sec (5 E-4) Helium leak.

Calibration procedure using 'ppm' units

Please read this entire procedure before proceeding with this calibration routine.



* Fill an empty (uncontaminated) sample bag with 5000 ppm Helium gas before starting the calibration procedure. Also remove the outer grey probe from the GasCheck G.

* Select the 'Custom Cal' symbol from the instruments menu. An option appears allowing the adjustment of the 'ppm' value to ensure the instrument matches the gas concentration being used. Use the UP and DOWN keys to adjust between 4900 and 5100 ppm.

* Ensure the instrument is in clean air and then press the ENTER key, the instrument will Zero, this will take a few seconds but once complete a 'Ready' message will appear.

* Insert the instruments probe fully into the sample bag containing the gas and press the ENTER key. The instrument will automatically sequence through the cold and hot stages of calibration but when finished gives a summary of values.

* Press the ENTER key to return back to the calibration option screen. Press the ESC key to start using the instrument or press the ENTER key to calibrate again.

NOTE: To avoid errors in calibration the following points should be noted:-

- * Avoid bending the inner probe as this will affect the GasCheck G's accuracy.
- * GasCheck G can detect changes in Humidity and Carbon dioxide, therefore avoid breathing on the probe.
- * Avoid pressurizing the sample bag as this will cause significant errors in reading

Calibration procedure using 'cc/sec' units

Please read this entire procedure before proceeding with this calibration routine.



- * Follow the instructions of the CalCheck unit, the pointer of the pressure gauge must resting over the green segment.
- * select the 'Custom Cal' symbol from the instruments menu.
- * Ensure the instrument is in clean air and then press the ENTER key, the instrument will Zero, this will take a few seconds but once complete a 'Ready' message will appear.
- * Insert the instruments probe into the CalChecks outlet and press the ENTER key. The instrument will automatically sequence through the cold and hot stages of calibration but when finished gives a summary of values.
- * Pressing the ENTER key will return back to the calibration option screen. Press the ESC key to start using the instrument or press the ENTER key to recalibrate again.

NOTE:

* GasCheck G can detect changes in Humidity and Carbon dioxide, therefore avoid breathing on the probe.

Part No.	Description	Used
A-21500	0.0005 cc/sec Helium Calibration kit	For when GasCheck G is used with cc/s units

WARNING: Great care should be taken to ensure the calibration gas is neither pressurised or restricts flow to the instruments probe. Changes in flow of gas to the sensor will result in significant errors in readings.

Replacing Batteries

Before using the GasCheck G instrument ensure the batteries are fitted correctly or ensure NiMH (rechargeable) batteries are fully charged before use.

To fit or replace batteries you must first remove the battery cover from the rear of the instrument. This can be done by prising open the battery clip with a finger nail or screw driver.

Removing the battery cover will reveal a battery holder, which requires 4 x AA size batteries. Before removing old batteries or fitting new ones unclip the battery holder from the instrument by prising apart the PP3 type clip shown in the illustration.

Once the battery holder is disconnected from the instrument, the batteries can be removed or replaced however care must be taken when refitting the batteries to ensure they are the correct polarity, polarity markings are moulded on to the battery holder plastic.

The battery holder can be reconnected to the GasCheck G by firmly pressing the two halves of the PP3 clip together. Care should be taken to ensure the polarity is correct, see the PP3 diagram (right).

The battery pack is then laid within the instrument and the battery cover refitted, be careful not to trap wires when refitting the battery cover.

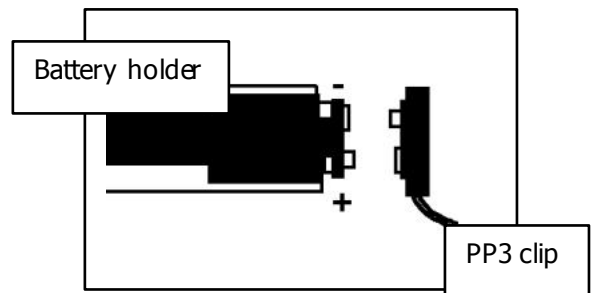
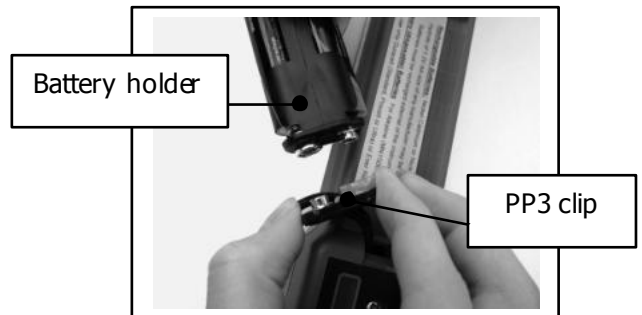
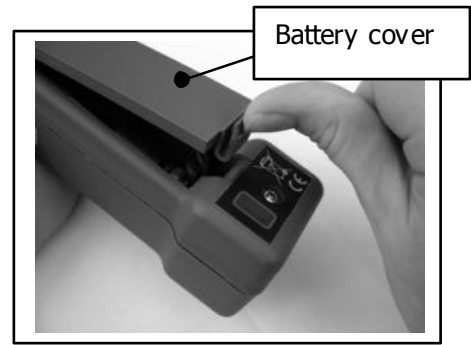

Instrument Specification

Operating temperature	0 to 50 °C	32 to 122 °F
Storage temperature	-25 to 70 °C	-13 to 158 °F
Instrument case	Polyurethane	
Dimensions	L.390 x W.60 x H.50 mm	L15.35" x W2.35" x 2.0 "
Weight	0.5 kg	1.0 lb.
Ingress ratings	IP20	
Length of long probe	300 mm	12"
Detection type	Thermal conductivity	
Detection time to T90	1 sec (Short probe)	9 sec (long probe)
Clear down time	1 sec (Short probe)	9 sec (long probe)
Battery type	Alkaline or NiMH AA (Qty 4)	
Battery life at 20 °C (68 °F).	40 Hours (20 hours when using the backlight)	

Replacement parts

Part	Item Number
Long probe	A-08045
Short probe	A-08043
Replacement battery holder 3000	1/BH-01
Nozzle	08024CPC8
Box Spanner	A-08029
Accessory	Item Number
CalCheck	A-21500 (specifying gas, leak rate and pressure)

Update Log

Manual Version	Amendment	Date updated	Instrument Firmware	PC Software
GasCheck G V1.4	Gas Table Update	16/7/08	V1.31	N/A
GasCheck G V1.5	Instrument Update	22/8/08	V1.31	N/A
GasCheck G V1.6	BSEN 61326 – 1997 to BSEN 61326 – 2006. Change to page 2 only	23/9/08	V1.31	N/A
GasCheck G V1.7	Declaration of conformity updated	20/11/08	V1.31	N/A
GasCheck G V1.8	Log added to back of manual	09/01/09	V1.31	N/A