

MiniRAE 2000

Portable VOC Monitor PGM-7600

OPERATION AND MAINTENANCE MANUAL

(Document No.: 011-4001)
Rev. C



RAE SYSTEMS INC.
1339 Moffett Part drive
Sunnyvale, CA 94089

November 2001



RAE Systems Product Line

- **Gas Detection Tubes & Pumps**
 - **SampleRAE Electronic Sampling Pump**
 - **MultiRAE PLUS Multi-gas Monitors**
 - **MultiRAE IR Multi-gas Monitors w/CO₂**
 - **MultiRAE Confined Space Monitor**
 - **QRAE PLUS Multi-gas Monitors**
 - **QRAE Confined Space Monitor**
 - **VRAE Five-Gas Monitors**
 - **DRAE Two-Gas Monitors**
 - **MiniRAE 2000 Portable VOC Monitor (PID)**
 - **ppbRAE Portable ppb-Level VOC Monitor (PID)**
 - **UltraRAE Specific Compound Monitor**
 - **CDRAE Corona Discharge VOC Monitor**
 - **ToxiRAE PLUS PID Monitor**
 - **ToxiRAE PLUS Single Gas Monitors**
 - **ToxiRAE PLUS Oxygen Monitor**
 - **ToxiRAE PLUS Combustible Gas Monitor**
 - **MiniRAE PLUS Classic PID**
 - **ModuRAE Fixed System PID**
 - **AreaRAE Wireless Multi-point, Multi-gas Systems**
-

How can I be informed and updated?

Be sure to mail in your warranty card via email, post or fax to get on RAE's private database (information is never supplied to others).

You will be updated on new products, technical advisory notices, new accessories and much more. Thank you for your purchase!

Table of Contents

1. GENERAL INFORMATION.....	1-1
1.1 General Specifications	1-2
2. OPERATION OF MINIRAE 2000.....	2-1
2.1 Physical Description	2-2
2.2 Keys and Display	2-3
2.3 Power On/Off.....	2-5
2.4 Operation.....	2-7
2.4.1 Survey Mode	2-8
2.4.2 Hygiene Mode	2-13
2.5 Alarm Signals.....	2-15
2.6 Preset Alarm Limits and Calibration	2-17
2.7 Integrated Sampling Pump.....	2-18
2.8 Back Light.....	2-19
2.9 Datalogging.....	2-20
3. OPERATION OF ACCESSORIES.....	3-1
3.1 Standard Kit and Accessories	3-2
3.2 Optional Accessories.....	3-5
4. PROGRAMMING OF MINIRAE 2000.....	4-1
4.1 Programming Mode	4-2
4.2 Keys for Programming Mode	4-3
4.3 Entering into Programming Mode	4-4
4.4 Calibrate and Select Gas	4-5
4.4.1 Fresh Air Calibration.....	4-8
4.4.2 Span Calibration.....	4-9
4.4.3 Select Cal Memory.....	4-11
4.4.4 Change Span Value	4-12
4.4.5 Modify Cal Memory.....	4-13
4.4.6 Change Correction Factor.....	4-15
4.5 Change Alarm Limits.....	4-16
4.5.1 Change Low Alarm Limit	4-18
4.5.2 Change STEL Limit	4-19
4.5.3 Change TWA Limit	4-20
4.6 View or Change Datalog.....	4-21

4.6.1	Reset Peak/Minimum	4-22
4.6.2	View Data (Datalog)	4-23
4.6.3	Clear Data	4-25
4.6.4	Change Data Period	4-26
4.6.5	Change Average Type	4-27
4.7	Change Monitor Setup	4-28
4.7.1	Change Operation Mode	4-29
4.7.2	Change Site ID	4-30
4.7.3	Change User ID	4-31
4.7.4	Change Alarm Mode?	4-32
4.7.5	Change User Mode	4-33
4.7.6	Change Date	4-34
4.7.7	Change Time	4-35
4.7.8	Change Lamp	4-36
4.7.9	Change Unit	4-37
4.7.10	Change Dilution Ratio	4-38
4.7.11	Change Output?	4-39
4.7.12	Change DAC Range?	4-40
4.7.13	Set Temperature Unit?	4-41
4.8	Exit Programming Mode	4-42
5.	COMPUTER INTERFACE.....	5-1
5.1	Installing ProRAE-Suite Software	5-2
5.2	Connect MiniRAE 2000 to PC	5-4
5.3	Start ProRAE-Suite Software	5-5
5.4	Setup Communication Port	5-7
5.5	Processing the Configuration Data	5-8
5.5.1	Editing the Configuration Data	5-9
5.5.2	Send Configuration	5-16
5.5.3	Saving Configuration Data	5-17
5.5.4	Configuring All Settings	5-18
5.6	Processing the Logged Data	5-19
5.6.1	Receiving Data	5-20
5.6.2	View Logged Data in Text Mode	5-21
5.6.3	View STEL/TWA/AVG Value	5-23
5.6.4	View Summary Information	5-24

5.6.5	View Logged Data in Graph Mode	5-25
5.6.6	Exporting Data to a Text File	5-29
5.6.7	Exporting Graphics to a File.....	5-30
5.6.8	Printing Logged Data	5-31
5.7	Installing Datalog Capability	5-32
5.8	Upgrade the Firmware	5-34
6.	THEORY OF OPERATION	6-1
7.	MAINTENANCE	7-1
7.1	Battery Charging and Replacement	7-1
7.2	PID Sensor & Lamp Cleaning /Replacement	7-4
7.3	Sampling Pump	7-7
7.4	Turning on the UV Lamp.....	7-9
8.	TROUBLESHOOTING	8-1
8.1	Special Diagnostic Mode	8-2
8.2	Troubleshooting Table	8-10
	APPENDIX A. QUICK REFERENCE GUIDE	A-1
	APPENDIX B. REPLACEMENT PARTS LIST.....	B-1
	APPENDIX C. TECHNICAL NOTES	C-1
	APPENDIX D. APPLICATION NOTES	D-1
	APPENDIX E. LITERATURE REQUEST	E-1
	APPENDIX F. REQUEST FOR RETURN	
	AUTHORIZATION FORM.....	F-1
	Main Contact Numbers	Outside Back Cover



- Do NOT proceed before reading -

This manual must be carefully read by all individuals who have or will have the responsibility for using, maintaining, or servicing this product.

The product will perform as designed only if it is used, maintained, and serviced in accordance with the manufacturer's instructions.

CAUTION!!

To reduce the risk of electric shock, turn off power before removing the monitor cover. Disconnect the battery before removing sensor module for service. Never operate the monitor while the cover is removed. Remove monitor cover and sensor module only in an area known to be non-hazardous.

The model PGM-7600 equipment is classified as to intrinsic safety for use in class I, division 1, groups A, B, C, D, or non-hazardous locations only.

Special Notes

-1-

When the MiniRAE 2000 Monitor is taken out from the transport case and turned on for the first time, there may be some residual organic or inorganic vapor trapped inside the detector chamber. The initial PID sensor reading may indicate a few ppm. Enter an area known to be free of any organic vapor and turn on the monitor. After running for several minutes, the residual vapor in the detector chamber will be cleared and the reading should return to zero.

-2-

The battery of the MiniRAE 2000 monitor will discharge slowly even if it is turned off. If the monitor has not been charged for 5-7 days, the battery voltage will be low. Therefore, it is a good practice to always charge the monitor before using it. It is also recommended to fully charge the monitor FOR AT LEAST 10 HOURS before first use. See Section 7 for more information on battery charging and replacement.

STATIC HAZARD:

Clean only with damp cloth.

DANGER RISQUE D'ORIGINE

ELECTROSTATIQUE:

Nettoyer uniquement avec un chiffon humide.

CAUTION:

For safety reasons this equipment must be operated and serviced by qualified personnel only. Read and understand instruction manual completely before operating or servicing.

ATTENTION:

Pour des raisons de sécurité, cet équipement doit être utilisé, entretenu et réparé uniquement par un personnel qualifié. Étudier le manuel d'instructions en entier avant d'utiliser, d'entretenir ou de réparer l'équipement.

WARNINGS:

Use only RAE Systems battery packs, part nos. 012-3050, 012-3051 or 012-3052. This instrument has not been tested in an explosive gas/air atmosphere having an oxygen concentration greater than 21%. Substitution of components may impair intrinsic safety. Recharge batteries only in non-hazardous locations.

AVERTISSEMENT:

Utiliser seulement l'ensemble de batterie RAE Systems, la référence 012-3050, 012-3051 au 012-3052. Cet instrument n'a pas été essayé dans une atmosphère de gaz/air explosive ayant une concentration d'oxygène plus élevée que 21%. La substitution de composants peut compromettre la sécurité intrinsèque. Ne charger les batteries que dans emplacements désignés non-dangereuse.

CAUTION WARNINGS:

The calibration of all newly purchased RAE Systems instruments should be tested by exposing the sensor(s) to known concentration calibration gas before the instrument is put into service.

For maximum safety, the accuracy of the MiniRAE 2000 should be checked by exposing it to a known concentration calibration gas before each day's use.

AVERTISSEMENT:

La calibration de toute instruments de RAE Systems doivent être testé en exposant l'instrument a une concentration de gaz connue par une procédure diétalonnage avant de mettre en service l'instrument pour la première fois.

Pour une securite maximale, la sensibilité du MiniRAE 2000 doit être verifier en exposant l'instrument a une concentration de gaz connue par une procédure di étalonnage avant chaque utilisation journalière.

1. GENERAL INFORMATION

MiniRAE 2000 Portable VOC Monitor (Model PGM 7600) is a compact monitor designed as a broadband VOC gas monitor and datalogger for work in hazardous environments. It monitors Volatile Organic Compounds (VOC) using a Photo-Ionization Detector (PID) with a 9.8 eV, 10.6 eV, or 11.7 eV gas discharge lamp. Features are:

- **Lightweight and Compact**
 - Compact, light weight (19 oz.) and rugged design
 - Built-in sample draw pump
- **Dependable and Accurate**
 - Up to 10 hours of continuous monitoring with rechargeable battery pack
 - Designed to continuously monitor VOC vapor at ppm levels
- **User Friendly**
 - Preset alarm thresholds for STEL, TWA, low and high level peak values. Audio buzzer and flashing LED display are activated when the limits are exceeded.
- **Datalogging Capabilities**
 - 15,000 point datalogging storage capacity for data download to PC

MiniRAE 2000 consists of a PID with associated microcomputer and electronic circuit. The unit is housed in a rugged ABS + PC case with a backlit 1 line by 8 character dot matrix LCD and 3 keys to provide easy user interface.

1.1 General Specifications

Table 1.1

Portable VOC Monitor Specification	
Size:	8.2"L x 3.0"W x 2.0"H
Weight:	19.5 oz with battery pack
Detector:	Photo-ionization sensor with 9.8, 10.6, or 11.7 eV UV lamp
Battery:	A 4.8V /1250 mAH Rechargeable Nickel Metal Hydride battery pack (snap in, field replaceable)
Battery Charging:	10 hours charge through built-in charger
Operating Hours:	Up to 10 hours continuous operation
Display:	1 line by 8 characters 5x7 dot matrix LCD (0.4" character height) with LED back light automatically in dim light
Range, Resolution & Response time (t ₉₀):	
Isobutylene (calibration gas)	
0-99 ppm	0.1 ppm 2 sec
100-1,999 ppm	1.0 ppm 2 sec
2000-10,000 ppm	1.0 ppm 2 sec
Measurement Accuracy (Isobutylene):	
0 – 2000 ppm:	± 2 ppm or 10% of reading.
> 2000 ppm:	± 20% of reading
PID Detector:	Easy access to lamp and sensor for cleaning and replacement
Correction Factors:	Built-in 102 VOC gases

GENERAL INFORMATION

Calibration:	Two-point field calibration of zero and standard reference gas
Calibration Memory:	Store up to 8 separate calibration, alarm limits and span value
Inlet Probe:	Flexible 5" tubing
Keypad:	1 operation key and 2 programming keys
Direct Readout:	Instantaneous, average, STEL and peak value, battery voltage and elapsed time
Intrinsic Safety:	UL & cUL Class 1, Division I, Group A,B,C,D, Temperature Code T3C (US & Canada); EEx ia IIC T4 (Europe)
EM Interference:	No effect when exposed to 0.43 W/cm ² RF interference (5 watt transmitter at 12 inches)
Alarm Setting:	Separate alarm limit settings for Low, High, STEL and TWA alarm
Operating Mode:	Survey or Hygiene mode
Alarm:	90 dB buzzer and flashing red LEDs to indicate exceeded preset limits, low battery voltage, or sensor failure.
External Alarm:	Optional plug-in pen-size vibration alarm or remote alarm
Alarm Mode:	Latching or automatic reset

GENERAL INFORMATION

Real-time Clock:	Automatic date and time stamps on data logged information
Datalogging:	15,000 points with time stamp, serial number, user ID, site ID, etc.
Communication:	Upload data to PC and download instrument setup from PC through RS-232 port
Sampling Pump:	Internally integrated. Flow rate: 450-550 cc/min.
Temperature:	0° to 45°C (32° to 113°F)
Humidity:	0 % to 95 % relative humidity (non-condensing)
Housing:	ABS + PC, conductive coating, splash and dust proof, will withstand 1 meter drop test with rubber boot
Attachment:	Wrist strap, rubber boot and belt clip

2. OPERATION OF MINIRAE 2000

The MiniRAE 2000 Portable VOC Monitor is a compact Monitor designed as a broadband VOC gas monitor and datalogger for work in hazardous environments. It gives real time measurements and activates alarm signals whenever the exposure exceeds preset limits. Prior to factory shipment the MiniRAE 2000 is preset with default alarm limits and the sensor is pre-calibrated with standard calibration gas. However, the user should test the instrument and verify the calibration before the first use. After the monitor is fully charged and calibrated, it is ready for immediate operation.

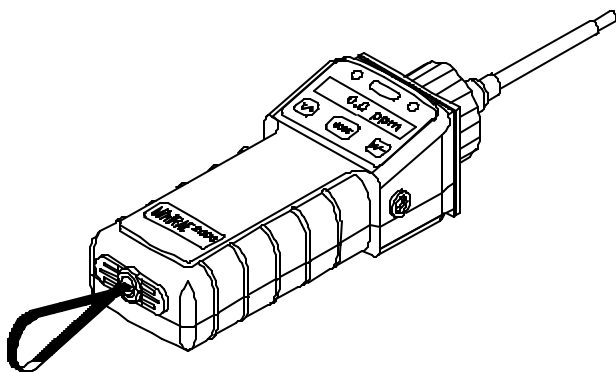

Figure 2-1 MiniRAE 2000

2.1 Physical Description

The main components of the MiniRAE 2000 Portable VOC monitor include:

- Three keys for user to interact with the monitor: 1 operation key and 2 programming keys for normal operation or programming of the monitor
- LCD display with back light for direct readout and calculated measurements
- Buzzer and red LED's for alarm signaling whenever the exposures exceed preset limits
- Wrist strap
- Charge contact for plugging directly to the charging station
- Gas entry and exit ports
- Serial communication port for PC interface
- External alarm and analog output port
- Protective rubber cover

2.2 Keys and Display

Figure 2.2 shows the LCD display and the keypad on the front panel of the monitor. The function of the 3 keys during normal operation are summarized below:

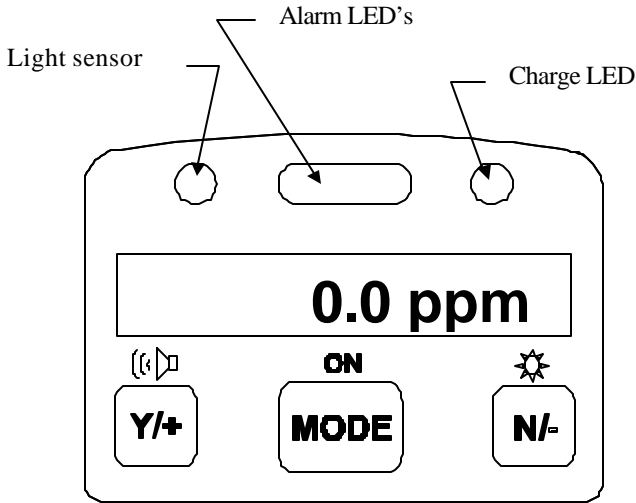

Figure 2-2 LCD Display and Keypad

Key	Function in Normal Operation
[MODE]	-Turn on/off the power* and step through menu items
[N/-]	-Toggle on/off the back light, negative acknowledge/decrement value
[Y/+]	-Start measurement, positive acknowledge/increment value

* Pressing and holding **[MODE]** key for 5 seconds turns off the power to the monitor. Monitor will beep once per second and display countdown timer during power-down sequence. Press **[MODE]** key momentarily to step through menu items. To save time, press any key during message scrolling to skip to the end of the message.

2.3 Power On/Off

To turn on the MiniRAE 2000 portable VOC monitor, press **[MODE]** key for one second and release. The audio buzzer will beep once and the air pump will turn on. The display will show “ON!..” and then “Ver n.nn” to indicate the unit’s current firmware version number. Next displayed are the serial number, the model number, Operating mode, current date and time, unit internal temperature, gas selected, high low, STEL, TWA/AVG alarm limits, battery voltage, and shut off voltage. Also displayed are internal mode settings such as User mode, Alarm mode, datalog time remaining and log periods in the respective order.

To turn off the MiniRAE 2000 portable VOC monitor, press and hold the **[MODE]** key for 5 seconds. The monitor will beep once per second during the power-down sequence with a count down timer showing the number of remaining seconds. The message “Off!..” flashes on the LCD display and the display will go blank indicating that the monitor is turned off.

Data protection during power off

When the monitor is turned off, all the current real time data including last measured value are erased. However, the datalog data is preserved in non-volatile memory. Even if the battery is disconnected, the datalog data will not be lost. While the power is off, the real time clock will continue to operate until the battery is completely drained (usually in 4-5 days without any charging). If the battery

is completely drained or is disconnected from the monitor for more than 30 minutes, the real time clock will be lost. In this case, the user needs to enter the real time clock information again, as described in Section 4, or send the PC clock during configuration through the PC communication.

2.4 Operation

The **MiniRAE 2000** VOC monitor has two operation modes: **Survey** and **Hygiene** mode. The **Survey mode** allows the user to manually start and stop the monitoring/measuring operation and display certain exposure values. In the **Hygiene mode**, the monitor runs continuously after the monitor is turned on. Refer to Section 4.7.1 for switching between the two modes.

2.4.1 Survey Mode

After the monitor is turned on, it runs through the start up menu. Then a message “Ready..” is displayed (see figure below). At this point, the user has two options; 1) step through the operation menu, or 2) take a measurement.

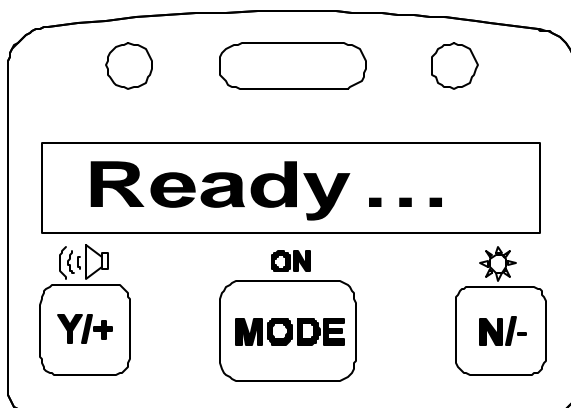

Press the **[MODE]** key to cycle through the idle operation menu. The PID sensor and pump are turned off during this idle operation.

Main operation menu displays include:

- “Ready...”
- Avg reading
- Peak reading
- Run time
- Current battery voltage and shutdown voltage
- Date, time and temperature
- Log on/off?
- PC communication?
- Survey, Site ID and Gas Name

The displays are arranged in a “round robin” order:
 To choose a specific display, press the **[MODE]** key one or more times until the desired display appears.

SURVEY MODE MAIN MENU

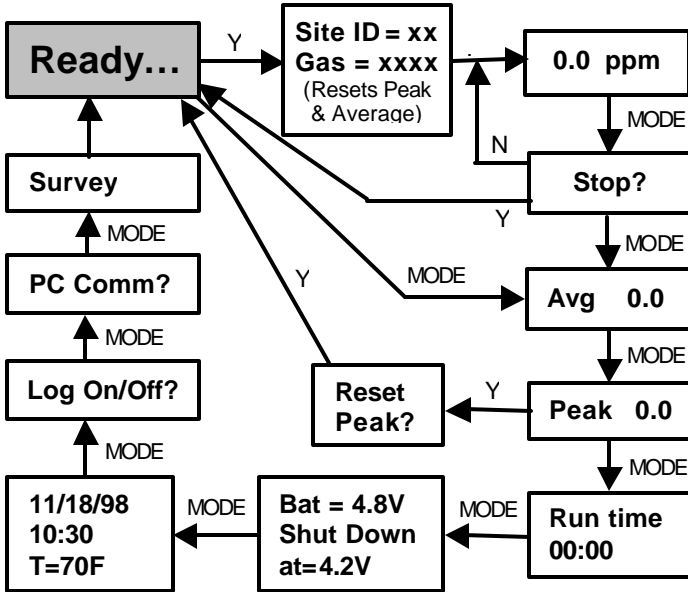

Notes: The Site ID, Gas, Stop? ppm Reading and Stop? screens are only shown after a measurement has been started, not during idle operation. The Log On/Off? screen is not shown when datalogging is disabled. The Ready screen is skipped if the menu is cycled through while a measurement is running.

More Details on the Main Operation Menu:

- **READY:** The monitor is ready to take a measurement. Press the **[MODE]** key to advance to the next menu. Or Press **[Y/+]** key to start a measurement (read “**Taking a Measurement**” on page 2-11 for details).

- **AVERAGE READING:** The TWA or running average since the start of the measurement (see Section 4.6.5 to change). The average is recalculated every minute.
- **PEAK READING:** The highest instantaneous reading since the start of the measurement. If **[Y/+]** is pressed while the peak reading is displayed, the unit will ask “Reset Peak?” If **[Y/+]** is pressed again, the peak value will be cleared and the display will return to the “Ready” message or instantaneous reading. The peak reading is automatically reset when a new measurement is started by pressing **[Y/+]** from the “Ready...” screen.
- **RUN TIME:** The current measurement has been last.
- **CURRENT BATTERY VOLTAGE and SHUT DOWN VOLTAGE:** The present battery voltage is displayed.

Note: A fully charged battery pack should show 4.8 volts or higher. When the battery voltage falls below 4.4 volts, a flashing “Bat” will appear as a warning message. There are about 20-30 minutes of run time left before the monitor turns off automatically, when the battery voltage falls below 4.2 volts.

- **DATE, TIME, TEMPERATURE:** This menu displays the current date (month/day/year), time (24-hour format), and internal unit temperature in degrees Fahrenheit.
- **LOG ON/OFF?** Allows the user to start datalogging of the current measurement. A superscript “L” flashes in the ppm measurement display when datalogging is on.

Note: Before datalogging can be turned on, this function must be enabled as described in Section 4.6.4.

- **PC COMMUNICATION:** Allows the user to upload data from the MiniRAE 2000 to a Personal Computer (PC) or send/receive configuration information between a PC and the MiniRAE 2000. Connect the monitor to a serial port of a PC, and start the MiniRAE 2000 application software. Press the **[Y/+]** key and the LCD displays “pause monitor, ok?” Press the **[Y/+]** key one more time, the display shows “Comm...” The monitor is now ready to receive commands from the PC.
- **CURRENT OPERATING MODE:** The monitor displays the current operating mode e.g.; “Survey”, the site ID, gas name and then returns to “Ready..”

To choose a specific display, press the **[MODE]** key one or more times until the desired display appears.

Taking a measurement:

There are two ways to start a measurement. 1) Operating in Hygiene mode. 2) Manually start and stop measurement in Survey mode. To start a measurement in Hygiene mode, please refer to Section 4.7.1 on “Change Op mode”. To start a measurement in Survey mode, the MiniRAE 2000 monitor must first be in the “Ready...” mode. This is the mode to which the monitor normally powers up.

Measurement phases:

- **Ready**
- **Start measurement**
- **Measurement Display and datalogging**
- **Stop measurement**

Ready

The unit is ready to start a measurement.

Start Measurement

Press the **[Y/+]** key to start the measurement cycle.

The display will show the site ID and then the gas selected for measurement. The pump will start and the reading will be displayed. The peak and average values will be automatically reset to zero.

Measurement Display and Datalog

Instantaneous readings of the gas concentration in parts per million (ppm) are updated every second. A flashing superscript “L” is displayed when datalogging is on. Datalog information is saved only after one full datalog period is completed (see Section 4.6.5).

Stop Measurement

Press the **[MODE]** key and the display shows “ STOP?” Press **[N/-]** to continue measurement and **[Y/+]** to stop the measurement and datalog event. The pump stops automatically when measurement is stopped. Peak and average values for the current measurement can be read in idle mode until a new measurement is started.

Automatic Increment of Site ID

Every time a measurement is taken, the site ID will be incremented by one automatically in Survey mode.

Variable Alarm Signal

If the measurement exceeds the low limit, the buzzer and flashing alarm are activated. The frequency of the alarm is proportional to the measurement value. At values above the low alarm, the buzzer and LED will beep and flash twice per second and above the high alarm limit, three times per second (See Section 2.5).

2.4.2 Hygiene Mode

In Hygiene Mode, the unit will continuously taking measurements, once the power is turned on. After the initial start-up sequence displaying the current monitor settings, the LCD displays the instantaneous readings.

The Hygiene operation menu displays include:

- **Real time readings in ppm**
- **Current TWA/Avg, STEL and Peak values (see Section 4.6.6)**
- **Run time**
- **Current battery voltage**
- **Date, time and temperature**
- **Log on/off?**
- **Gas name**
- **PC communication?**
- **Hygiene**

Detailed description of most of these displays are the same as Section 2.4.1.

HYGIENE MODE MAIN MENU

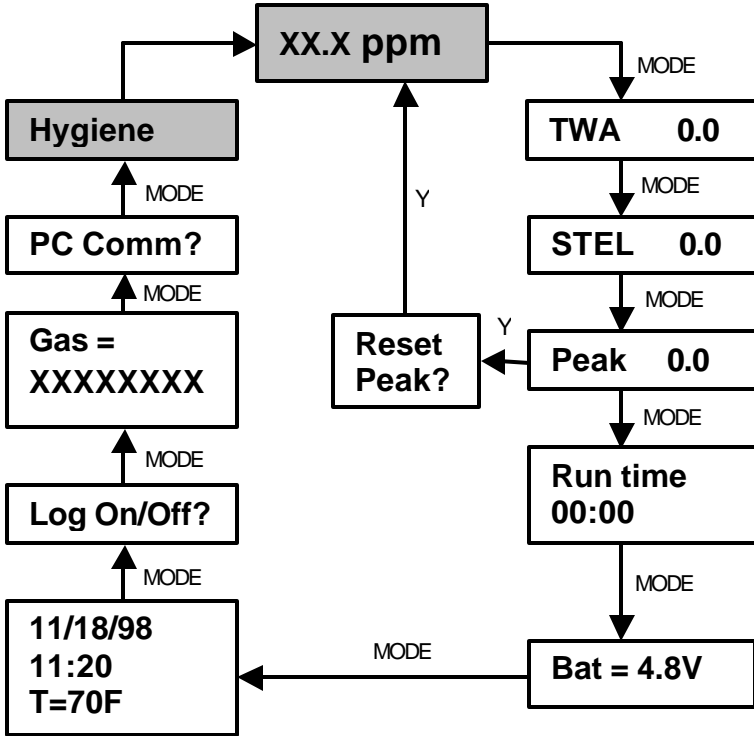

To choose a specific display, press the **[MODE]** key one or more times until the desired display appears, or the **[Y/+]** key where indicated with a Y.

Note: To get back to instantaneous reading from any of the above display, press **[MODE]** key repeatedly until the “XX.X ppm” display appears.

2.5 Alarm Signals

During each measurement period, the gas concentration is compared with the programmed alarm limits (gas concentration alarm limit settings: Low, High, TWA and STEL). If the concentration exceeds any of the preset limits, the loud buzzer and red flashing LED are activated immediately to warn the user of the alarm condition.

In addition, the MiniRAE 2000 will alarm if one of the following conditions occurs: battery voltage falls below a pre-set voltage level (4.4 V), failure of UV lamp, pump stall, or when the datalog memory is full. When the low battery alarm occurs, there will be approximately 20-30 minutes of operating time remaining. When the battery voltage falls below 4.2 V, the monitor will turn off automatically.

Alarm Signal Summary:

Condition	Alarm Signal
Gas exceeds "High Alarm" limit	3 beeps/flashes per second
Gas exceeds "Low Alarm" limit	2 beeps/flashes per second
Gas exceeds "TWA" limit	1 Beeps/flashes per seconds
Gas exceeds "STEL" limit	1 Beeps/flashes per seconds
Pump failure	3 beeps/flashes per second plus "Pump" message on LCD
PID lamp failure	3 beeps/flashes per second plus "Lamp" message on LCD
Low battery	1 flash per second, 1 beep per minute plus "Bat" message on LCD
Memory full	1 flash per second plus "Mem" message on LCD

Alarm Signal Testing:

Under normal non-alarm conditions, it is possible to test the MiniRAE 2000 LED and buzzer in Special Diagnostic Mode (see Section 8 for details).

2.6 Preset Alarm Limits and Calibration

The MiniRAE 2000 portable VOC monitor is factory calibrated with standard calibration gas, and is programmed with default alarm limits. There are 102 gas settings stored in the library. Some examples of calibration and alarm limits are shown below. Refer to Section 4 on programming procedures for selecting a different gas, perform a calibration or set new alarm limits.

Factory Calibration and Preset Alarm Limits						
Cal Gas	Cal Span	unit	Low	High	TWA	STEL
Isobutylene	100	ppm	50	100	100	250
Hexane, n-	100	ppm	500	750	500	750
Xylene, m-	100	ppm	100	150	100	150
Benzene	5	ppm	2	5	5	2
Styrene	50	ppm	20	40	20	40
Toluene	100	ppm	50	100	50	100
Vinyl Chloride	10	ppm	5	10	5	10
Custom	100	ppm	50	100	50	100

2.7 Integrated Sampling Pump

The MiniRAE 2000 portable VOC monitor includes an integrated sampling pump. This is a diaphragm type pump that provides a 500-600 cc per minute flow rate. Connecting a Teflon or metal tubing with 1/8 inch inside diameter to the gas inlet port of the MiniRAE 2000, this pump can pull in air samples from 200 feet away horizontally, or 90 feet vertically, at about 3 feet per second flow speed.

The pump turns on when a measurement is started, and turns off when the sample is manually stopped in Survey mode or when the unit is turned off from Hygiene Mode.

If liquid or other objects are pulled into the inlet port filter, the monitor will detect the obstruction and shut down the pump immediately. The alarm will be activated and a flashing error message “Pump” will be also displayed on the LCD display.

The user should acknowledge the pump shut off condition by clearing the obstruction and pressing the **[Y/+]** key to re-start the pump.

The pump stall threshold is set in the special Diagnostic Mode (Section 8).

2.8 Back Light

The LCD display is equipped with an LED back light to assist in reading the display under poor lighting conditions. Pressing and holding the [N/-] key for one second in normal operation can turn on the backlight. The backlight can be turned off by pressing **[N/-]** a second time. If the **[N/-]** key is not pressed, the back light will be turned off automatically after a pre-programmed time-out period to save power.

In addition, the ambient light is sensed and the back light will be turned on automatically if the ambient light is below a threshold level. The back light is turned off automatically when the ambient light exceeds the threshold level.

See Section 8 for instructions on how to set the light threshold level.

Note: The LED backlight consumes about 20-30% of the total average current, when the instrument is idle or not taking a measurement.

2.9 Datalogging

During datalogging, the MiniRAE 2000 Portable VOC monitor flashes a superscript “L”, on the display to indicate that datalogging is enabled. The monitor stores the time stamp, sample number, and measured gas concentration at the end of every sample period (when data logging is enabled). In addition, the following information are stored: user ID, site ID, serial number, last calibration date, and alarm limits. All data are retained (even after the unit is turned off) in non-volatile memory so that it can be down loaded at a later time to a PC.

Datalogging event

When Datalogging is enabled, measurement readings are being saved. These data are stored in “groups” or “events. A new event is created and stored each time the monitor is turned on, or a configuration parameter is changed, or datalogging is interrupted (e.g. Communication with PC during Hygiene mode). Information, such as start time, user ID, site ID, gas name, serial number, last calibration date, and alarm limits will be recorded.

Datalogging sample

After an event is recorded, the unit records a shorter form of the data. This data contains: the sample number, time (hour/minute) and gas concentration.

3. OPERATION OF ACCESSORIES

The accessories for the MiniRAE 2000 include:

- An AC Adapter (Battery Charger)
- Alkaline battery holder
- Water Trap Filter

Optional Accessories:

- Dilution Fitting
- Calibration adapter
- Calibration regulator and Flow controller
- Organic Vapor Zeroing kit

3.1 Standard Kit and Accessories

1) AC Adapter (Battery Charger)

WARNING:

To reduce the risk of ignition of hazardous atmospheres, recharge battery only in area known to be non-hazardous. Remove and replace battery only in area known to be non-hazardous.

Ne charger les batteries que dans emplacements designés non-dangereuses.

A battery charging circuit is built into the MiniRAE 2000 monitor. It only needs a regular AC to 12 V DC adapter (wall mount transformer) to charge the monitor.

To charge the battery inside the MiniRAE 2000 monitor:

1. Power off the Monitor.
2. Connect the AC adapter (or the optional automotive charging adapter) to the DC jack on the MiniRAE 2000 monitor. If the unit was off, it will automatically turn on.
3. The first message displayed will be “Deep discharge?” The unit will ask this question for three times. If the user wants to discharge the battery pack, affirm this query with the **[Y/+]** key, otherwise the unit will move on to the charge mode directly.

4. While charging, the display message will alternate between “Charging” and “Bat=x.xV” (x.x is the present battery voltage). The LED should be red in color when charging.

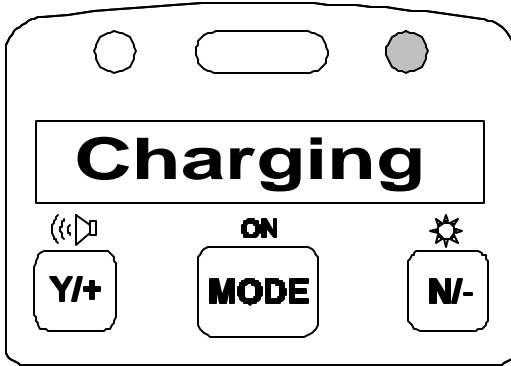

5. When the battery is fully charged, the LED will change from red to green and the message “Fully charged” will appear on the display. After the battery is fully charged, the unit will enter the “trickle charge” mode. In which, the red LED will turn on for several seconds every minute, to maintain the full charge.

A completely discharged MiniRAE 2000 monitor will be charged to full capacity within 10 hours. The battery will be drained slowly even if the monitor is turned off. If the monitor has not been charged for 7-10 days, the battery voltage will be low.

The factory-supplied battery is designed to last for 10 hours of normal operation (no alarm, no back light condition), for a new battery under the best condition. As the battery becomes older or is subject to adverse conditions (such as cold ambient temperature), the battery capacity will be reduced significantly.

2) Alkaline Battery Holder

An alkaline battery holder is supplied with each MiniRAE 2000. It accepts four AA size alkaline batteries and can be used in place of the Ni-MH or Ni-Cd battery pack to provide approximately 12-14 hours of operation. The adapter is intended to be used in emergency situations when there is no time to charge the Ni-Cd or Ni-MH battery pack.

To install the adapter, remove the cover of the battery compartment. Remove the Ni-Cd or Ni-MH battery pack from the battery compartment and replace with the alkaline battery adapter. Replace the battery compartment cover.

The internal charging circuit is designed to prevent damage to alkaline batteries and the charging circuit when alkaline batteries are installed inside the monitor.

Note: The AA Alkaline battery adapter supplied by RAE Systems Inc. is intrinsically safe!

3) Water Trap Filter

The water trap filter is made of PTFE (Teflon[®]) membrane with a 0.45 micron pore size to prevent water from being sucked into the sensor manifold, which would cause extensive damage to the monitor. It will also remove any dust and other particles from entering the monitor and prolong the operating life of the sensor. To install the water trap, simply insert it to the front of the inlet tube of the MiniRAE 2000 monitor.

3.2 Optional Accessories

1) Dilution Fitting

The user may wish to install a dilution fitting on the inlet to dilute the gas samples. One application for a dilution fitting is to measure organic gas when the concentration exceeds the upper limit of the sensor range.

Make sure to set the dilution ratio in the programming mode (see Section 4.7.9) so that the correct gas reading will be displayed when the dilution fitting is used.

WARNING: To use a dilution fitting, the user must have the monitor located in a clean atmosphere outside the confined space and use a remote access probe or Tygon tubing to measure the gas concentration inside the confined space.

2) Calibration Adapter

The calibration adapter for the MiniRAE 2000 is a simple 6-inch Tygon tubing with a metal adapter on one end. During calibration, simply insert the metal adapter into the regular gas inlet probe of the MiniRAE 2000 and the tubing to the gas regulator on the gas bottle.

3) Calibration Regulator and Flow Controller

The Calibration Regulator and Flow controller is used in the calibration process. It regulates the gas flow rate from the Span gas cylinder into the gas inlet of the MiniRAE 2000 monitor during calibration process. The maximum flow rate allowed by the flow controller is about 0.5L/min

(500 cc per min.). Alternatively, a Demand-flow Regulator or a Tedlar gas bag may be used to match the pump flow precisely.

4) Organic Vapor Zeroing kit (Charcoal filter)

The Organic Vapor Zeroing Kit is used for filtering organic air contaminants that may affect the zero calibration reading. To use the Organic Vapor Zeroing Kit, simply connect the filter to the inlet port of the MiniRAE 2000.

4. PROGRAMMING OF MINIRAE 2000

The MiniRAE 2000 Monitor is built with a microcomputer to provide programming flexibility. Authorized users can re-calibrate the monitor, change the alarm limits, change site ID, user ID, lamp type, and real time clock, etc.

Programming is menu-driven to provide intuitive end-user operation. The display shows the menu options and the key pad used for menu selection and data entry.

4.1 Programming Mode

The programming mode allows the users to change the setups in the monitor, calibrate the monitor, modify the sensor configuration and enter user information, etc. The programming mode has four menu items. Each menu item includes several sub-menus to perform additional programming functions. Appendix A shows a more detailed menu tree structure.

Programming Menu
Calibrate/Select Gas?
Change Alarm Limits?
View or Change Datalog?
Change Monitor Setup?

Once inside the programming mode, the LCD will display the first menu. Each subsequent menu item can be viewed by pressing the **[N/-]** repeatedly until the desired menu is displayed. To enter the sub-menu of a particular menu, press **[Y/+]** key, the sub-menu will be displayed.

Return to Operation mode: To exit the programming mode and return to operation, press the **[MODE]** key once at any of the programming menu displays.

4.2 Keys for Programming Mode

The three keys perform a different set of functions during the programming mode as summarized below.

Key	Function in Programming Mode
[MODE]:	Exit menu when pressed momentarily or exit data entry mode when pressed and held for 1 second
[Y/+]:	Increase alphanumerical value for data entry or confirm (yes) for a question
[N/-]:	Decrease alphanumerical value for data entry or deny (no) for a question

4.3 Entering into Programming Mode

1. Turn on the MiniRAE 2000 monitor and wait for the “**Ready..**” message or the instantaneous reading display “**0.0 ppm**” message displayed.
2. Press and hold down both **[N/-]** and **[MODE]** keys for three seconds to enter programming mode. This delay is to prevent the user from entering programming mode by accident.
3. The first menu item “Calibrate/select Gas?” will be displayed.
4. Release both **[MODE]** and **[N/-]** keys simultaneously to start the programming mode
5. Press **[N/-]** key to scroll to the next menu item of the programming menu. Press **[Y/+]** key to select the displayed menu item.

The following Sections 4.4 - 4.7 describe the details of each menu options.

4.4 Calibrate and Select Gas

CAUTION WARNINGS:

The calibration of all newly purchased RAE Systems instruments should be tested by exposing the sensor(s) to known concentration calibration gas before the instrument is put into service for the first time.

For maximum safety, the accuracy of the MiniRAE 2000 should be checked by exposing it to known concentration calibration gas before each day's use.

In the first menu of the programming mode, the user can perform functions such as calibration of the MiniRAE 2000 Monitor, select default cal memories, and modify cal memories (see Table 4.4).

Table 4.4

Calibrate/Select Gas Sub-Menu
Fresh Air Cal?
Span Cal?
Select Cal Memory?
Change Span Value?
Modify Cal Memory?
Change Correction Factor?

Calibrating the MiniRAE 2000 monitor is a two-point process using “fresh air “ and the standard reference gas (also known as span gas). First a “Fresh air” calibration, which contains no detectable VOC (0.0 ppm), is used to set the zero point for the sensor. Then a standard reference

gas that contains a known concentration of a given gas is used to set the second point of reference.

Note: The span value must be set prior to calibrating for fresh air or span.

The user can store calibrations for up to 8 different measurement gases. The default gas selections are as follows:

Cal Memory #0.....Isobutylene
Cal Memory #1.....Hexane
Cal Memory #2.....Xylene
Cal Memory #3.....Benzene
Cal Memory #4.....Styrene
Cal Memory #5.....Toluene
Cal Memory #6.....Vinyl Chloride
Cal Memory #7.....Custom?

Memory #0 functions differently than the other 7 memories. For Memory #0, isobutylene is always the calibration gas. When the gas is changed in Memory #0 to one of 100 other preprogrammed chemicals or to a user-defined custom gas, a correction factor is applied to all the readings. During calibration, the unit requests isobutylene gas and displays the isobutylene concentration immediately following calibration, but when the unit is returned to the normal reading mode, it displays the selected gas and applies the correction factor.

The other 7 cal memories require the same calibration gas as the measurement gas. These memories may also be modified to a preprogrammed chemical or to a user-defined custom gas. In the gas library, only the gases that

can be detected by the installed UV lamp will actually be displayed. Note that although the correction factor for the new gas will be displayed and can be modified, this factor is not applied when Memories #1-7 are used. Therefore the factor will not affect the readings in these memories.

Once each of the memories has been calibrated, the user can switch between the calibrated gases by changing the cal memory without the need to recalibrate. Or the user can switch the measurement gas in Memory #0 and the appropriate correction factor will automatically be applied without the need to recalibrate. If the gas is changed in Memories #1-7, it is necessary to recalibrate.

To change a default gas from the list above to a library or custom gas, first go to Select Cal Memory (Section 4.4.3) and then proceed to Modify Cal Memory (Section 4.4.5) to enter the desired gas. If the desired compound does not appear in the preprogrammed library, the user can use the Custom_VOC entry in the library, or the name and correction factor of any of the existing compounds can be changed as described in Section 4.4.5. A list of some 300 correction factors is given in Technical Note 106, available at the website www.raesystems.com.

4.4.1 Fresh Air Calibration

This procedure determines the zero point of the sensor calibration curve. To perform a fresh air calibration, use the calibration adapter to connect the MiniRAE 2000 to a “fresh” air source such as from a cylinder or Tedlar bag (option accessory). The “fresh” air is clean dry air without any organic impurities. If such an air cylinder is not available, any clean ambient air without detectable contaminant or a charcoal filter can be used.

1. The first sub-menu shows: “Fresh air Cal?”
2. Make sure that the MiniRAE 2000 is connected to one of the “fresh” air sources described above.
3. Press the **[Y/+]** key, the display shows “zero in progress” followed by “wait..” and a countdown timer.
4. After about 15 seconds pause, the display will show the message “zeroed... reading = X.X ppm...” Press any key or wait about 20 seconds, the monitor will return back to “Fresh air Calibration?” submenu.

Note: The charcoal filter has a check box so that user can mark off a box each time the filter has been used. The charcoal filter should be replaced after 20 calibrations.

4.4.2 Span Calibration

This procedure determines the second point of the sensor calibration curve for the sensor. A cylinder of standard reference gas (span gas) fitted with a 500 cc/min. flow-limiting regulator or a flow-matching regulator is the simplest way to perform this procedure. Choose the 500 cc/min. regulator only if the flow rate matches or slightly exceeds the flow rate of the instrument pump. Alternatively, the span gas can first be filled into a Tedlar Bag, or delivered through a demand-flow regulator. Connect the calibration adapter to the inlet port of the MiniRAE 2000 Monitor, and connect the tubing to the regulator or Tedlar bag.

Another alternative is to use a regulator with >500 cc/min flow but allow the excess flow to escape through a T or an open tube. In the latter method, the span gas flows out through an open tube slightly wider than the probe, and the probe is inserted into the calibration tube.

Before executing a span calibration, make sure the span value has been set correctly (see next sub-menu).

1. Make sure the monitor is connected to one of the span gas sources described above.
2. Press the **[Y/+]** key at the “Span Cal?” to start the calibration. The display shows the gas name and the span value of the corresponding gas.
3. The display shows “Apply gas now!” Turn on the valve of the span gas supply.

4. Display shows “wait... 30” with a count down timer showing the number of remaining seconds while the monitor performs the calibration.
5. To abort the calibration, press any key during the count down. The display shows “Aborted!” and return to “Span Cal?” sub-menu.
6. When the count down timer reaches 0, the display shows the calibrated value.

Note: The reading should be very close to the span gas value.

7. During calibration, the monitor waits for an increased signal before starting the countdown timer. If a minimal response is not obtained after 35 seconds, the monitor displays “No Gas!” Check the span gas valve is on and for lamp or sensor failure before trying again.
8. The calibration can be started manually by pressing any key while the “Apply gas now!” is displayed.
9. After a span calibration is completed, the display will show the message “Span Cal Done! Turn Off Gas.”
10. Turn off the flow of gas. Disconnect the calibration adapter or Tedlar bag from the MiniRAE 2000 Monitor.
11. Press any key and it returns back to “Span Gas Cal?”

4.4.3 Select Cal Memory

This function allows the user to select one of eight different memories for gas calibration and measurement. For Memories #1-7, the calibration and measurement gas is the same and no correction factor is applied. For Memory #0, the calibration gas is always isobutylene and the measurement gas may be different, in which case the correction factor for that gas is automatically applied. The default gas selections are listed in Section 4.4

1. “Select Cal Memory?” is the third sub-menu item in the Calibration sub-menu. Pressing the **[Y/+]** key, the display will show “Gas =” gas name followed by “Mem # x?”
2. Press **[N/-]** to scroll through all the memory numbers and the gas selections respectively. Press **[Y/+]** to accept the displayed Cal Memory number.
3. After the **[Y/+]** key is pressed, the display shows “Save?” Press **[Y/+]** key to save and proceed. Press **[N/-]** to discard the entry and advance to the next sub-menu.
4. If the gas in a newly selected Cal Memory number is not calibrated, the display shows “CF= x.xx”. A correction factor with the value “x.xx” will be applied.
5. If the gas of a newly selected cal memory number has been calibrated previously, the display shows “Last calibrated xx/xx/xx”.

4.4.4 Change Span Value

This function allows the user to change the span values of the calibration gases.

1. “Change Span Value?” is the fourth sub-menu item in the Calibration sub-menu
2. Press **[Y/+]**, display shows the gas name and the span value. A cursor will blink at the first digit of the Span value. To modify the span gas value, go to Step 3. Otherwise, press and hold the **[MODE]** key for 1 second to accept the previously stored span gas value and move to the next sub-menu.
3. Starting from the left-most digit of the span gas value, use the **[Y/+]** or **[N/-]** key to change the digit value and press **[MODE]** key momentarily to advance to next digit. Repeat this process until all digits are entered. Press and hold the **[MODE]** for 1 second to exit.
4. The display shows “Save?” To accept the new value, press the **[Y/+]** key. Press the **[N/-]** key or the **[MODE]** key to discard the change and move to the next sub-menu.

4.4.5 Modify Cal Memory

If the current cal memory number selected is not memory 0, users will be prompted whether to modify the settings of the selected cal memory. Press **[Y/+]** to modify the cal memory and **[N/-]** to go to the next sub-menu.

Once **[Y/+]** is pressed the LCD display will show the current memory number, current Gas selected and prompt user for acceptance of current gas selected.

1. Press **[N/-]** to modify the gas selection if desired. Or press **[Y/+]** key to skip the change of gas selection, and proceed to the next sub-menu.
2. After pressing **[N/-]**, display shows “Copy gas from library?” Press **[Y/+]** to accept or **[N/-]** for the next sub-menu, “Enter Custom gas?”
3. In the “Copy gas from library” submenu, use **[Y/+]** and **[N/-]** keys to scroll through the selections in the library. Press **[MODE]** key momentarily to select the gas. The display shows ”Save?” Press **[Y/+]** to save or **[N/-]** to discard the changes and proceed to next sub-menu.
4. In the Custom gas sub-menu, the user can enter the gas name. Press the **[Y/+]** or **[N/-]** key to cycle through all 26 letters and 10 numerals. Press the **[MODE]** key momentarily to advance to the next digit. The flashing digit will move to the next digit to the right. Repeat this process until all digits (up to 8 digits) of the custom gas name is entered.

Press and hold the **[MODE]** key for 1 second to exit the name entry mode. The display will show "Save?" Press **[Y/+]** to save the entry, or **[N/-]** to discard the changes.

4.4.6 Change Correction Factor

This function allows the user to change the Correction Factor of the standard calibration gas (only for Cal Memory #0).

1. “Change Correction Factor?” is the sixth sub-menu in the Calibration sub-menu.
2. Press **[Y/+]** key. Display shows the gas name, then the correction factor.

A cursor blinks at the left-most digit of the correction factor. If user wants to modify the correction factor, go to Step 3. Otherwise, press and hold the **[MODE]** key for 1 second to accept the previously stored correction factor value and return to the first sub-menu of the calibrate/select gas menu.

3. Starting from the left-most digit of the correction factor, use **[Y/+]** or **[N/-]** key to change the digit value and press **[MODE]** key momentarily to advance to the next digit, the cursor will move to the next digit to the right. Repeat this process until all digits are entered. Press and hold the **[MODE]** for 1 second to exit.
4. The display shows “Save?” To confirm the new value, press **[Y/+]** to accept the change. Press **[N/-]** or **[MODE]** to discard the change and return to the first sub-menu, Calibrate and Select Gas.

4.5 Change Alarm Limits

In this menu, the user can change the high and low alarm limits, the STEL limit and the TWA limit (see Table 4.5 below). Press the **[Y/+]** key and the display shows the current gas selected followed by the first sub-menu item below.

Table 4.5

Alarm Limit Sub-Menu
Change High Alarm limit?
Change Low Alarm limit?
Change STEL limit?
Change TWA limit?

1. Scroll through the Alarm Limit sub-menu using the **[N/-]** key until the display shows the desired limit to be changed, e.g., "High limit?", "STEL limit?", etc.
2. Press the **[Y/+]** key to select the desired limit and the display shows a flashing cursor on the left-most digit of the previously stored alarm limit.

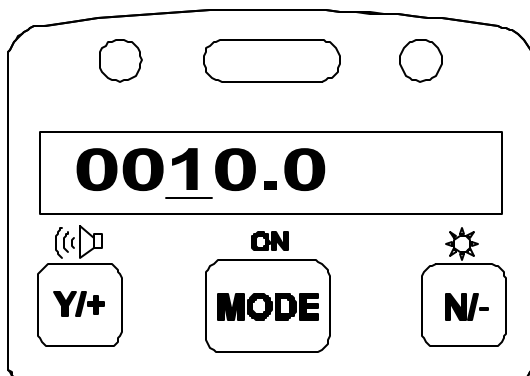

3. To modify this limit value, use the **[Y/+]** or **[N/-]** key to change the digit value and press the **[MODE]** key momentarily to advance to the next digit. The flashing digit will move to the next digit to its right. Repeat this process until the new limit value is entered. Press and hold the **[MODE]** key for 1 second to exit data entry mode.
4. If there is any change to the existing value, the display shows "Save?" Press **[Y/+]** to accept the new value and move to the next sub-menu. Press **[N/-]** to discard the changes and move to the next sub-menu.

4.5.1 Change Low Alarm Limit

The second sub-menu item in the Alarm Limit sub-menu allows the user to change the Low Alarm limit. The LCD displays ‘Low limit?’ To change Low Alarm limit, press **[Y/+]** key, or Press **[N/-]** key advance to next sub-menu in Table 4.5.

1. Press **[Y/+]** and the display will show a flashing cursor on the left-most digit of the previously stored Low alarm limit.
2. To modify this limit value, use the **[Y/+]** or **[N/-]** key to change the digit value and press the **[MODE]** key momentarily to advance to the next digit. The flashing digit will move to the next digit to its right. Repeat this process until the new limit values is entered. Press and hold the **[MODE]** key for 1 second to exit data entry mode.
3. If there is any change to the existing value, the display shows “Save?” Press **[Y/+]** to accept the new value and move to the next sub-menu. Press **[N/-]** to discard the changes and move to the next sub-menu.

4.5.2 Change STEL Limit

This sub-menu item allows the user to change the STEL limit. The display shows “STEL limit?”

1. Press the **[Y/+]** key and the display will show a flashing cursor on the left-most digit of the previously stored STEL limit.
2. To modify this limit value, use the **[Y/+]** or **[N/-]** key to change the digit value and press the **[MODE]** key momentarily to advance to the next digit. The flashing digit will move on to next digit to its right. Repeat this process until the new limit values is entered. Press and hold the **[MODE]** key for 1 second to exit data entry mode.
3. If there is any change to the existing value, the display shows “Save?” Press **[Y/+]** to accept the new value and move to the next sub-menu. Press **[N/-]** to discard the changes and move to the next sub-menu.

4.5.3 Change TWA Limit

This sub-menu item allows the user to change the TWA limit. The LCD displays “TWA limit?”

1. Press **[Y/+]** and the display will show a flashing cursor on the left-most digit of the previously stored TWA limit.
2. To modify this limit value, use the **[Y/+]** or **[N/-]** key to change the digit value and press the **[MODE]** key momentarily to advance to the next digit. The flashing digit will move on to next digit to its right. Repeat this process until the new limit values is entered. Press and hold the **[MODE]** key for 1 second to exit data entry mode.
3. If there is any change to the existing value, the display shows “Save?” Press **[Y/+]** to accept the new value and move to the next sub-menu. Press **[N/-]** to discard the changes and move to the next sub-menu.

4.6 View or Change Datalog

The MiniRAE 2000 monitor calculates and stores the concentration and ID of each sample taken. In the datalog sub-menu, a user can perform the tasks and functions shown in Table 4.6.

Table 4.6

Datalog Sub-Menu
Reset Peak/Minimum?
View Data?
Clear Data?
Change Data Period?
Change Average Type?

4.6.1 Reset Peak/Minimum

This function will reset the peak and minimum stored in the data memory. Note: this function will not clear the STEL or TWA data.

1. “Reset Peak/Minimum?” is the first sub-menu item in the Datalog sub-menu (Table 4.6).
2. Press the **[Y/+]** key to reset the Peak/Minimum Values. The display shows “Are You Sure?”
3. Pressing the **[Y/+]** key again will reset the values. The display shows “Peak/Minimum Cleared” and moves to the next submenu.
4. Press the **[N/-]** or **[MODE]** key to exit without resetting the values and move to the next sub-menu.

4.6.2 View Data (Datalog)

This function allows the user to review all the data that is stored in the non-volatile datalog memory.

Data are stored in groups, or “events”. Each event consists of event time (hour:minute:seconds), and measurement values. For example:

Event/Log #1	
Data #1	(10/01/97, 14:35:05, Avg., 0.2 PPM, Max 4.0)
Data #2	(14:35:10, Avg. 0.4, Max 11.0)
Data #3	(14:35:15, Avg. 0.4, Max 11.0)
Event/Log #2	
Data #1	(10/03/98, 07:20:30 ,Avg. 3.4, Max 20.0)
Data #2	(07:20:40, Avg. 0.7, Max 20.0)

1. “View Data?” is the second sub-menu item in the Datalog sub-menu.
2. Press the **[Y/+]** key and the display shows “Event..”

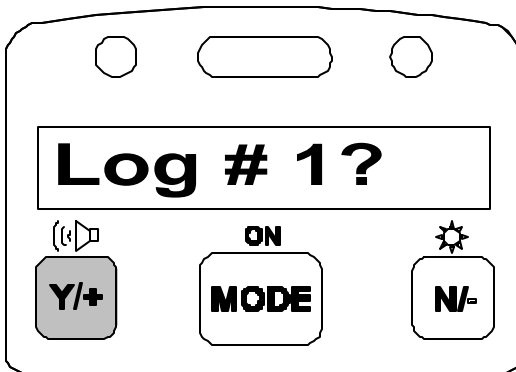

and “Log #1?” Press the **[Y/+]** key to view the data of the displayed event. Or press the **[N/-]** key to scroll to next event. If there are no more events, the message “No more events! Start from event #1?” will appear.

Press **[Y/+]** and the monitor will return to the first event. Press **[N/-]** and the monitor will remain in the last event.

3. Press **[Y/+]** to review the first data of the selected event. The display shows the stored data including the time stamp in hours and minutes, and measurement values.

Action	Display
	Event, Log# 1?
[Y/+]	10/01/97, 14:20:07, Avg. 2.0, Max 3.3
[Y/+]	14:20:08, Avg. 2.0, Max 3.4

4. Press the **[Y/+]** or **[N/-]** key to move forward or backward to view other data from this event. When the beginning or the end of the event is reached, the message "1st data" or "End data" will appear. Press the **[MODE]** key to exit the current event.

4.6.3 Clear Data

This function will erase all data stored in the non-volatile datalog memory. Note: This function does not change STEL, TWA, Peak, Minimum and run time values, which are stored in the regular data memory.

1. “Clear Data?” is the third sub-menu item in the Datalog sub-menu.
2. Press the **[Y/+]** key to clear the datalog memory. The display shows “Are you sure?”
3. Press the **[Y/+]** key again to confirm erasure of all the datalog memory.
4. Press the **[N/-]** or **[MODE]** key to exit without clearing the datalog memory and move to the next datalog sub-menu.

Change Data Period

The datalog period can be programmed from 1 to 3,600 seconds (1 hour).

1. “Change Data Period?” is the fifth sub-menu item in the Datalog sub-menu.
2. Press the **[Y/+]** key and the display shows “Datalog Period = XXXX” with the left-most digit flashing, where “XXXX” is the previously stored data log period.
4. To modify this period, starting from the left-most digit, use the **[Y/+]** or **[N/-]** key to change the digit value and press the **[MODE]** key momentarily to advance to the next digit. The flashing digit will move to the next digit to the right. Repeat this process until all 4 digits of the new period are entered. Press and hold the **[MODE]** key for 1 second to exit data entry mode.
5. If there is any change to the existing value, the display will show “Save?” Press **[Y/+]** to accept the new value or **[N/-]** to discard the changes and move to the next sub-menu.

4.6.5 Change Average Type

The user can select either an 8-hour Time Weighted Average (TWA) or a running Average. The running average is simply the average of all instantaneous (1-second) readings since the measurement was started. This average may increase or decrease with time depending on the readings. The TWA is a cumulative value used to estimate the fraction of the 8-hour limit to which the user has been exposed since the start of the measurement. This value can only increase or remain constant, never decrease. Refer to Technical Note 119 for more information on how TWA is calculated.

1. “Change Average Type?” is the sixth sub-menu in the Datalog sub-menu.
2. Press the **[Y/+]** key to enter the function.
3. The display will show “Running Average?” or “Time Weighted Average?” depending on the current average type.
4. Press **[N/-]** key to toggle between the average types. Press **[Y/+]** key to select the displayed average type.
5. If there is any change to the existing setting, the display shows “Save?” Press **[Y/+]** to save the change. Press **[N/-]** or **[MODE]** to discard the change and return to the first sub-menu.

4.7 Change Monitor Setup

Several monitor specific variables can be changed in this menu. The following is a list of configuration data that can be modified by the user.

Table 4.7

Monitor Setup Sub-Menu
Change Operation Mode?
Change Site ID?
Change User ID?
Change Alarm Mode?
Change User Mode?
Change Date?
Change Time?
Change Lamp?
Change Unit?
Change Dilution Ratio?
Change Output?
Change DAC Range?
Set Temperature Unit?

4.7.1 Change Operation Mode

MiniRAE 2000 supports two operation modes: Survey and Hygiene mode.

Survey mode: Manual start/stop of measurements and display of certain exposure values.

Hygiene mode: Automatic measurements, running and datalogging continuously and calculates additional exposure values.

1. “Change Op Mode?” is the first sub-menu item in the Monitor Setup menu (Table 4.7).
2. Press the **[Y/+]** key and the display shows the current user mode: “Op Mode = *current mode*?”
3. Press the **[Y/+]** key to accept the currently displayed operation (Op) mode. Press **[N/-]** to toggle to the other operation mode. Press **[MODE]** to exit this sub-menu and move to the next monitor setup sub-menu.
4. When changing Op mode from Hygiene to Survey, the display shows the additional message “Warning! Exit Hygiene?” to prevent accidental exit from Hygiene mode. Press the **[Y/+]** key to acknowledge.
5. If there is any change to the existing setting, the display will show “Save?” Press the **[Y/+]** key to accept or the **[N/-]** key to discard and move to the next sub-menu.

Note: If a new Op Mode is saved, the display shows “Op Mode changed!!” when exiting the programming mode.

4.7.2 Change Site ID

The user can enter an 8-digit alphanumeric site ID in the programming mode. This site ID will be included in the datalog report.

1. “Change Site ID?” is the second sub-menu item in the Monitor Setup menu (Table 4.7).
2. Press the **[Y/+]** key and the display shows the current site ID: “Site ID = xxxxxxxx” with the left most digit flashing.
3. Press the **[Y/+]** or **[N/-]** key to cycle through all 26 letters and 10 numerals. Press **[MODE]** momentarily to advance to the next digit. The flashing digit will move to the next digit to the right. Repeat this process until all 8 digits of the new site ID are entered.
4. Press and hold the **[MODE]** key for 1 second to exit the data entry mode.
5. If there is any change to the existing site ID, the display shows ‘Save?’ Press the **[Y/+]** key to accept the new site ID. Press the **[N/-]** key to discard the change and move to the next sub-menu.

4.7.3 Change User ID

The user can enter an 8-digit alphanumeric user ID in the programming mode. This user ID will be included in the datalog report.

1. “Change User ID?” is the third sub-menu item the Monitor Setup menu.
2. Press the **[Y/+]** key and the display shows the current user ID: “User ID = xxxxxxxx” with the left most digit flashing.
3. Press the **[Y/+]** or **[N/-]** key to cycle through all 26 letters and 10 numerals. Press **[MODE]** momentarily to advance to the next digit. The flashing digit will move to the next digit to the right. Repeat this process until all 8 digits of the new user ID are entered.
4. Press and hold the **[MODE]** key for 1 second to exit the data entry mode.
5. If there is any change to the existing user ID, the display shows “Save?” Press the **[Y/+]** key to accept the new user ID. Or press the **[N/-]** key to discard the changes and move to the next sub-menu.

4.7.4 Change Alarm Mode?

There are two different alarm modes: **Latched** and **Automatic Reset** (Auto Reset) in the MiniRAE 2000 that can be selected from the programming menu.

1. “Change Alarm Mode?” is the fourth sub-menu item in the Monitor Setup menu.
2. Press the **[Y/+]** key; the display shows the current alarm mode.
3. Press the **[Y/+]** key to accept the currently displayed alarm mode. Press **[N/-]** key to toggle to the other alarm mode. Press **[MODE]** to exit this sub-menu and move to the next monitor setup sub-menu.
4. If there is any change to the existing setting, the display will show “Save?” Press **[Y/+]** to save the change. Press **[N/-]** or **[MODE]** to discard the change and move to the next sub-menu.

4.7.5 Change User Mode

There are two different user modes: **Display** and **Program** that can be selected from the programming menu.

1. “Change User Mode?” is the fifth sub-menu item in the Monitor Setup menu (Table 4.7).
2. Press the **[Y/+]** key; the display shows the current user mode selected.
3. Press the **[Y/+]** key to accept the currently displayed user mode. Press **[N/-]** key to toggle to the alternate user modes. Press **[MODE]** to exit this sub-menu and move to the next monitor setup sub-menu.
4. If there is any change to the existing selection, the display shows messages “Program change” and “Are you sure?” Press **[Y/+]** to confirm the change or press **[N/-]** or **[MODE]** to discard the changes and move to the next sub-menu.

CAUTION: If the user mode is changed to **Display** mode, the user can no longer enter the programming mode. Therefore, the user can not change the user mode back to **Program** mode in normal mode.

To restore the user mode back to **Program** mode, turn the unit off and back on in Diagnostic Mode. Next enter Program mode by holding the **[MODE]** and **[N/-]** keys for three seconds. Enter the password at the prompt (the default is 0000). Once program mode is entered, go to the “Change Monitor Setup” / “Change User Mode” and change the mode back to **Program**.

An alternative way to change Display mode back to Program mode is through the PC and the ProRAE-Suite software (see Section 5.5.1).

4.7.6 Change Date

The MiniRAE 2000 monitor is equipped with a real time clock (RTC). The user can enter the correct date and time (see 4.7.7) for the real time clock.

1. “Change Date?” is the sixth sub-menu item in the Monitor Setup menu.
2. Press **[Y/+]** and the display shows the current date “mm / dd / yy” with the left most digit of the date flashing.
5. To modify this value, use the **[Y/+]** or **[N/-]** key to change the digit value and press the **[MODE]** key momentarily to advance to the next digit. The flashing digit will move on to next digit to its right. Repeat this process until the new date and time values are entered. Press and hold the **[MODE]** key for 1 second to exit data entry mode.
4. If there is any change to the existing value, the display shows “Save?” Press **[Y/+]** to confirm the new value or press **[N/-]** or **[MODE]** to discard the changes and move to the next sub-menu.

4.7.7 Change Time

To change the time in the RTC of the MiniRAE 2000:

1. “Change Time?” is the seventh sub-menu item in the Monitor Setup menu.
2. Press **[Y/+]** and the display shows the current time in the 24-hour format “hh : mm” with the left most digit of the time flashing.
3. To modify this value, use the **[Y/+]** or **[N/-]** key to change the digit value and press the **[MODE]** key momentarily to advance to the next digit. The flashing digit will move on to next digit to its right. Repeat this process until the new date and time values are entered. Press and hold the **[MODE]** key for 1 second to exit data entry mode.
4. If there is any change to the existing value, the display shows “Save?” Press **[Y/+]** to confirm the new value or press **[N/-]** or **[MODE]** to discard the changes and move to the next sub-menu.

4.7.8 Change Lamp

There are three UV lamps with different photon energies available for the PID sensor: **9.8 eV**, **10.6 eV** and **11.7 eV**. The user can select any one of the lamps from the programming mode.

1. “Change Lamp Type?” is the eighth sub-menu item in the Monitor Setup menu (Table 4.7).
2. Press the **[Y/+]** key; the display shows the current PID lamp selection.
3. Press the **[Y/+]** key to accept the currently displayed lamp. Press **[N/-]** key to scroll through the sub-menu for other lamp selections. Press **[MODE]** to exit this sub-menu and return to the next sub-menu in Table 4.7.
4. If there is any change to the existing selection, the display will show ‘Save?’ Press **[Y/+]** to save the new selection or press **[N/-]** or **[MODE]** to discard the change and return to the next sub-menu in Table 4.7.

4.7.9 Change Unit

User can change the display and datalog unit from parts per million (ppm) to milli-gram per cubic meter (mg/m^3).

1. “Change Unit?” is the ninth sub-menu item in the Monitor Setup sub-menu.
2. Press the **[Y/+]** key, the display should show the current unit “Display Unit = ppm?” or “Display Unit = mg?”
3. Press **[Y/+]** key to accept the currently displayed unit. Press **[N/-]** key to toggle to the other unit. Press **[MODE]** key to exit this sub-menu.
4. If there is any change to the existing selection, press **[Y/+]** to confirm the new selection or press **[N/-]** or **[MODE]** to discard the changes and move to the next sub-menu.

Caution:

1. **The correction factor in the gas library is calculated based on “ppm” unit. If “mg” unit is selected, the built-in correction factor library is not valid.**
2. **No automatic conversion between “ppm” and “ mg/m^3 ” reading is performed by the monitor.**
3. **When the unit name is changed from “ppm” to “mg”, the unit must be recalibrated with the span gas concentration entered in mg/m^3 . The converse rule applies when the unit is changed from “mg” to “ppm”.**

4.7.10 Change Dilution Ratio

If a dilution system is used upstream of the MiniRAE 2000 inlet port, the user can enter the dilution ratio (from 1 to 10) to compensate the readings. The unit will then display the actual concentration of the gas before dilution. The dilution ratio should be 1 in normal operation where no dilution gas is applied to the sample gas. Dilution improves accuracy and linearity when the concentrations are above a few thousand ppm.

1. “Change Dilution Ratio?” is the tenth sub-menu item in the Monitor Setup menu.
2. Press the **[Y/+]** key; the display shows the current dilution ratio: “Dilution Ratio = xx” with the left most digit flashing.
3. Press the **[Y/+]** or **[N/-]** key to increase or decrease the value of the digit. Press **[MODE]** momentarily to advance to the next digit. The flashing digit will move to the next digit to the right. Repeat this process until both digits of the new dilution ratio are entered.
4. Press and hold the **[MODE]** key for 1 second to exit the data entry mode and move to the next sub-menu.
5. If there is any change to the existing dilution ratio, the display shows “Save?” Press **[Y/+]** to confirm the new value or press **[N/-]** or **[MODE]** to discard the changes and move to the next sub-menu.

4.7.11 Change Output?

There are two different external output options: DAC (Analog output) and Alarm in the MiniRAE 2000 that can be selected from the programming menu. The alarm output can be used to connect to the optional vibration alarm (vibrator) only. The analog output, which is proportional to the gas concentration, can be connected a chart recorder or can be queried by a computer to download data in real time (see Technical Note 141).

1. “Change External Output?” is the eleventh sub-menu item in the Monitor Setup menu.
2. Press the **[Y/+]** key and the display shows the current output option selection: “Output = DAC?”
3. Press the **[Y/+]** key to accept the currently displayed output option. Press **[N/-]** to change to the other external option: “Output = Alarm?” Press **[MODE]** to exit this sub-menu and move to the next monitor setup sub-menu.
4. If there is any change to the existing selection the display will show “Save?” Then, press **[Y/+]** to save the change, press **[N/-]** to go back to Step 2, or press **[MODE]** to exit this sub-menu and move to the next monitor setup sub-menu.

4.7.12 Change DAC Range?

There are four different DAC (Digital-to-Analog Conversion) range values available in the **MiniRAE 2000: 20, 200, 2000 and 10K ppm**. The maximum 2.5V DC analog signal output from the unit will represent the range value chosen. (See **Figure 8-1 Communication/Alarm Connector** for analog signal output connection.)

1. “Change DAC Range?” is the twelfth sub-menu item in the Monitor Setup menu.
2. Press the **[Y/+]** key, the display shows the current DAC Range value: “DAC Range = 2000 ppm?”
3. Press the **[Y/+]** key to accept the currently displayed value. Press **[N/-]** to scroll through the sub-menu for other range values. Press **[MODE]** to exit this sub-menu and return to the first sub-menu in Table 4.7.
4. If there is any change to the existing selection, press the **[Y/+]** key and the display will show “Save?” Press the **[Y/+]** key to save the change or press the **[N/-]** key to discard and return to the first sub-menu in Table 4.7.

4.7.13 Set Temperature Unit?

The temperature display can be switched between Fahrenheit and Celsius units.

1. “Set Temperature Unit?” is the thirteenth sub-menu item in the Monitor Setup menu.
2. Press the **[Y/+]** key, and the display shows the current setting: “Temperature Unit = Fahrenheit?”
3. Press the **[Y/+]** key to accept the currently displayed value. Press **[N/-]** to select the sub-menu “Temperature Unit = Celsius?” Press **[MODE]** to exit this sub-menu and return to the first sub-menu in Table 4.7.
4. If there is any change to the existing selection, press the **[Y/+]** key and the display will show “Save?” Press the **[Y/+]** key to save the change and return to the first sub-menu in Table 4.7 or press the **[N/-]** key to discard and return to Step 3..

4.8 Exit Programming Mode

1. To exit programming mode from the first tier menu level, press the **[MODE]** key once.
2. To exit programming mode from 2nd tier sub-menu, press the **[MODE]** key twice.
3. To return to programming mode, press and hold down both the **[MODE]** and **[N/-]** keys for 3 seconds.

5. COMPUTER INTERFACE

Each MiniRAE 2000 is shipped with a software package, called ProRAE-Suite, and a serial computer interface cable.

This software package runs on any IBM compatible Personal Computer (PC) under Windows 95[®], Windows 98[®], Windows 2000[®], Windows NT[®] 4.0, Windows ME, and later environments. It allows the user to configure the MiniRAE 2000 through a user-friendly interface and send the configuration information from the PC to the MiniRAE 2000 monitor. Collected data can also be extracted from the MiniRAE 2000 to the PC in order to perform data analysis, report generation or record keeping. Installation and operation of this software package is described in the following Sections.

Note: The monitor does not need to be equipped with datalogging capability to use the ProRAE-Suite computer interface package.

5.1 Installing ProRAE-Suite Software

The ProRAE-Suite software package is available on 3.5” setup diskettes or can be downloaded from the website www.raesystems.com. To install the ProRAE-Suite software from a diskette, insert the first setup diskette into the “A” or “B” floppy disk drive. Click the **Start** button on the taskbar to display the start menu, then click the **Run** from the start menu to display the **Run** dialog box. If the setup diskette is in disk drive A, type A:\Setup.exe in the **Open** field, as shown in Figure 5-1.

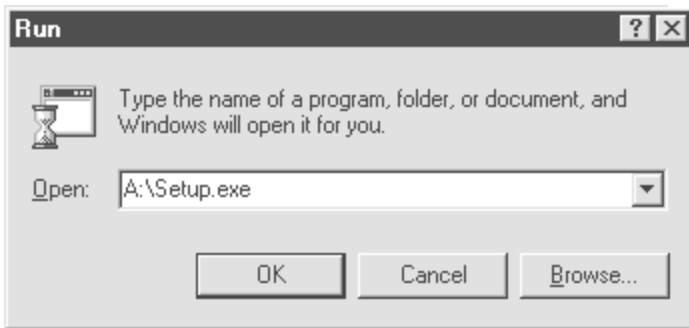

Figure 5-1 Run Dialog Box

Press the **Enter** key on the keyboard or click the **OK** button on the **Run** dialog box to start the setup process. If the user chooses the default settings in every step of the process, the ProRAE-Suite software will be installed under the default directory: **C:\Program Files\RAE Systems Inc\ProRAE-Suite**. After the software is installed successfully, a new menu item **ProRAE-Suite** is added to the **Programs** menu. To start the ProRAE-Suite software, click the **Start** button on the taskbar to display the **Start** menu, click the **Programs** menu item to display

the **Programs** submenu, then click the **ProRAE-Suite** menu item to display the **ProRAE-Suite** submenu. There are two submenu items under the **ProRAE-Suite** submenu: **ProRAE-Suite** and **Readme**, as shown in Figure 5-2. Click the **ProRAE-Suite** submenu item to start the ProRAE-Suite software.

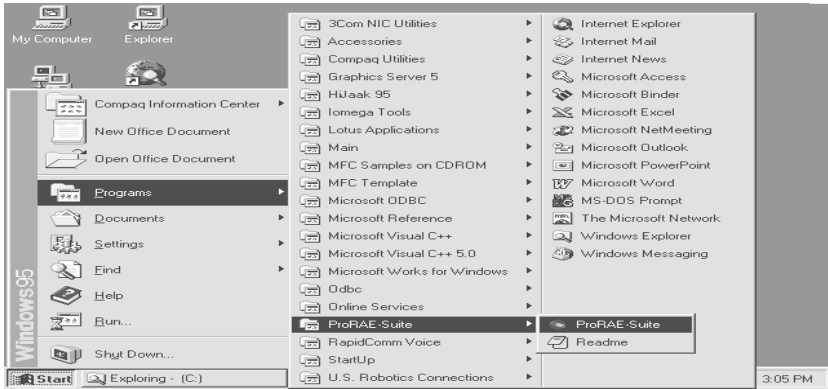

Figure 5-2 Start Menu

5.2 Connect MiniRAE 2000 to PC

The basic kit of the MiniRAE 2000 is supplied with a serial interface cable. Connect the DB-9 connector side of the cable to the serial port of the PC, and connect another side of the cable to the MiniRAE 2000 monitor.

Turn on the power to the MiniRAE 2000 monitor. Press the **[MODE]** key several times until the LCD shows ‘PC comm?’ Press the **[Y/+]** key and the display shows ‘Pause monitor, OK?’ Press **[Y/+]** to confirm and the display shows ‘Comm...’ to indicate that the MiniRAE 2000 monitor is ready and waiting for communication with the PC. During the communication session, the PC will directly control the MiniRAE 2000 monitor through the serial link. There is no need to press any key on the MiniRAE 2000 monitor during the communication session.

If no data transfer has occurred within two minutes, the MiniRAE 2000 monitor will return to instantaneous reading display.

<p>Note: Do not connect to the parallel port of the PC by mistake. The parallel port is usually a 25 pin female D connector on the back of the PC, the serial port is usually a 25 or 9 pin male D connector. If the serial port on the PC is a 25-pin connector, the user needs to use a 25 pin to 9-pin adapter in order to accept the serial cable.</p>

5.3 Start ProRAE-Suite Software

To start the ProRAE-Suite software, click the **Start** button on the taskbar to display the **Start** menu, then click the **Programs -> ProRAE-Suite -> ProRAE-Suite** submenu item to start the ProRAE-Suite software. Figure 5-3 shows the main window of the ProRAE-Suite software.

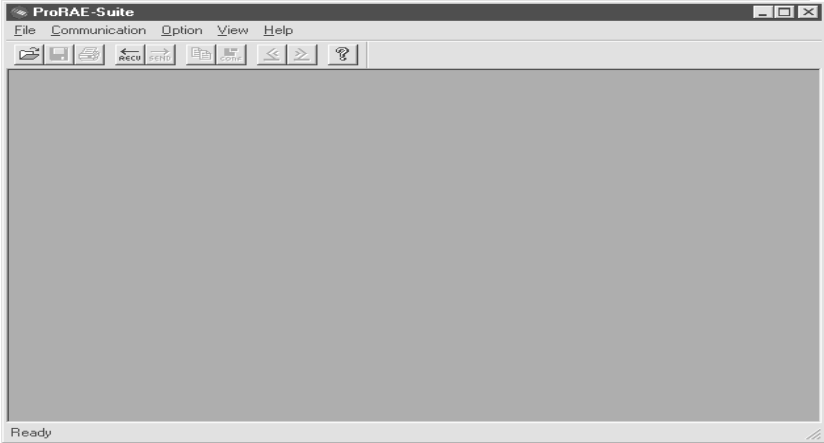

Figure 5-3 ProRAE-Suite Main Window

The functions of the ProRAE-Suite software can be divided into three categories:

- 1) Configuration data category. This category includes editing the configuration data file, sending the configuration data to the MiniRAE 2000 monitor and receiving the configuration data from the MiniRAE 2000 monitor, etc.
- 2) Logged data category. This category includes receiving logged data from the MiniRAE 2000 monitor, displaying logged data in different format,

and exporting logged data to a tab delimited text file so that it can be read by a spreadsheet program such as Microsoft Excel, etc.

- 3) Upgrade category. This category includes upgrading the monitor to datalogging capability, and upgrading the firmware in the monitor.

There is a tool bar beneath the menu bar. The frequently used functions are represented in this tool bar in the form of a small icon. For example, the **Receive data** function in the **Communication** sub-menu is represented as a small arrow with the letters "RECV". When the mouse cursor (a small arrow) is positioned near each icon in the tool bar, a short text will also appear at the bottom of the Window to describe the function of this icon.

This tool bar allows the user to invoke a function conveniently by clicking on the icon without going through the sub-menus.

5.4 Setup Communication Port

It is necessary to setup the communication port on the ProRAE-Suite software so that the MiniRAE 2000 monitor can communicate with the PC correctly. Figure 5-4 shows the **Setup Port** dialog box. Choose the appropriate port according to the PC's serial port setup.

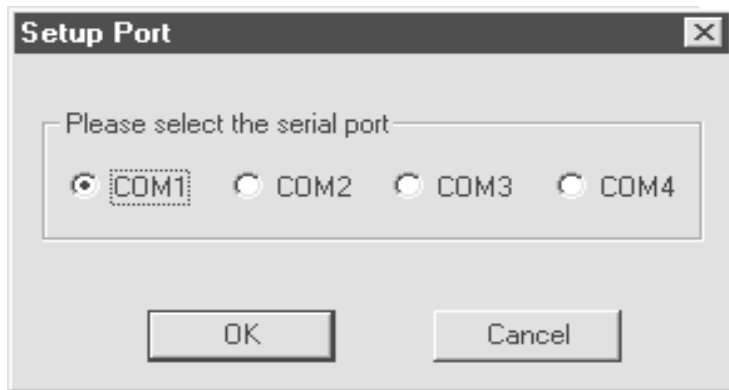

Figure 5-4 Setup Port Dialog

Note: In most PC's, there are two serial ports. Make sure that the serial port selected in the **Setup Port** dialog box matches the actual serial port connected to the MiniRAE 2000 monitor. The default serial port for ProRAE-Suite is COM1. If the incorrect serial port is selected, an error message of “error occur during serial port initialization” will appear when a user tries to communicate between the PC and the MiniRAE 2000 monitor.

5.5 Processing the Configuration Data

The ProRAE-Suite software allows the user to edit the configuration data, send the configuration data to the MiniRAE 2000 monitor, and receive the configuration data from the MiniRAE 2000 monitor. The following sub-sections describe the details of each operation.

5.5.1 Editing the Configuration Data

There are two different sources of the configuration files. One is loaded from the unit, the other is from a configuration file previously saved on the PC.

To load and review the configuration of the monitor: From the main menu of the ProRAE-Suite software, select the **Receive Configuration...** menu item from the **Communication** dropdown menu, then click the **OK** if the unit is connected to the communication port and ready.

To load a saved configuration file: From the main menu, select **Open** from the **File...** dropdown menu, a dialog box appears. Select the “Files of type:” to Config Files[*.cfg], as shown in Figure 5-5.

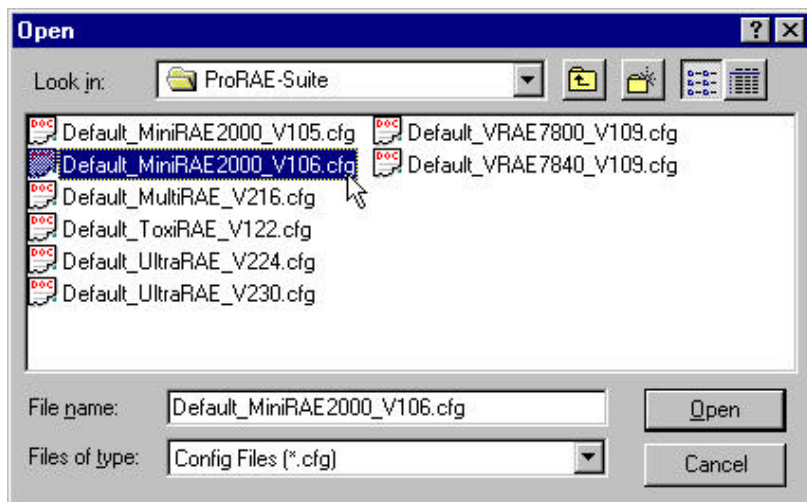

Figure 5-5 Open Dialog Box

There should be one or more configuration files in the file list. Each configuration file has a file extension of “.CFG”. There is one generic MiniRAE 2000 configuration file supplied with ProRAE-Suite software: **Default_MiniRAE2000_V####.CFG**, where #### is the version number of the default configuration file. For example, **Default_MiniRAE2000_V200.cfg** means this file is for **MiniRAE 2000** monitor and its version is V2.00. Choose a configuration file by highlighting the file name and press the **Enter** key or click the **Open** button on the dialog box.

Once the configuration file is open, the configuration data are displayed in the newly opened client window, as shown in Figure 5-6.

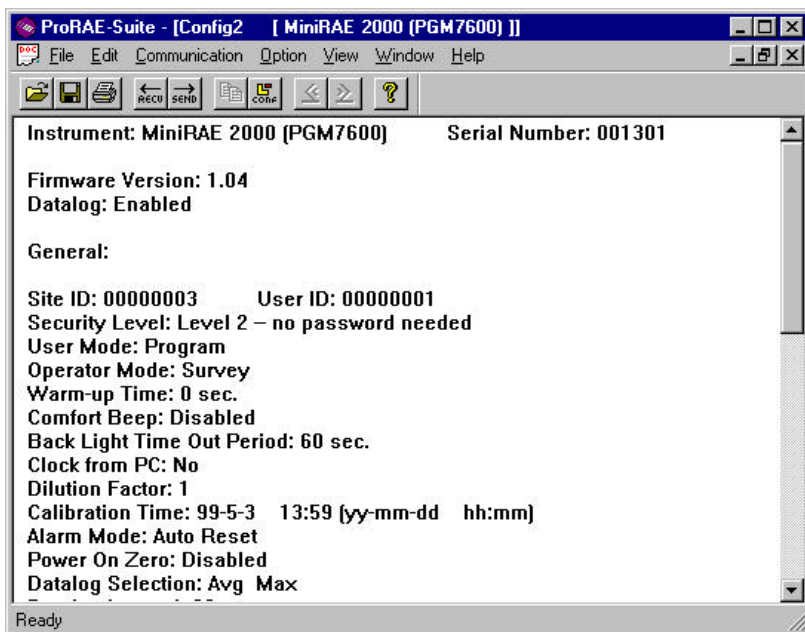

Figure 5-6 Displayed Configuration Data

To edit the opened configuration data file, click the **Edit - > Configuration** menu item or the **Configuration** toolbar button to open the **Edit Configuration File** dialog box, as shown in Figure 5-7. After editing the settings, click the **OK** button to close the **Edit Configuration File** dialog box. The new values of the configuration settings will be reflected in the client window.

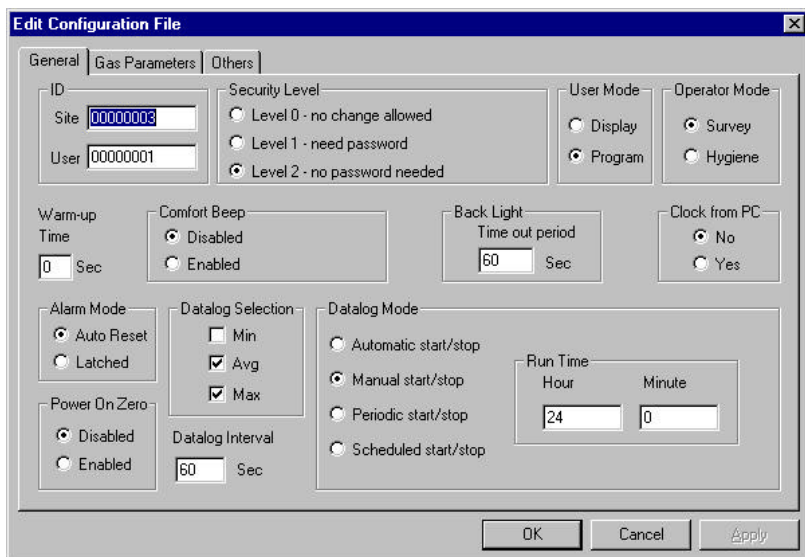

Figure 5-7 Edit Configuration File Dialog Box

The **General** tab page, which is shown in Figure 5-7, allows the user to change the general configuration settings. The following is the description of each field in the **General** tab page of the **Edit Configuration File** dialog:

ID:

This Section sets the identification that is used throughout the datalog process. Both editing fields, **Site** and **User**, can hold up to eight alphanumeric letters.

Security Level:

There are three levels of security. Use security level to provide protection against unauthorized changes to the monitor settings in the programming mode.

Level 0 allows the user to enter the programming menu without password checking, but does not allow changes to alarm limits, real time clock, correction factor, or user and site information, etc. The user can still perform calibrations.

If **Level 1** is selected, a four-digit password is required to enter the programming menu.

If **Level 2** is selected, the programming menu may be entered without restriction. Any changes made in the programming menu can be saved.

Password:

Entry to the programming menu requires the four-digit password be punched in if Level 1 is selected as the security level.

User Mode:

In the **Display** mode, the user can view several readings in the normal operation, but can not enter the programming menu. In the **Program** mode, the user can enter the programming mode to calibrate the monitor or change various setups in the monitor.

Operation Mode:

There are two operation modes the user can set: Hygiene and Survey mode. Hygiene mode is a continuous measurement mode. Survey mode is a manual start and stop measure mode. See chapter 2 for more details on the Hygiene and Survey mode.

Warm-up Time:

This option allows the user to choose the warm-up time of the instrument, in seconds.

Comfort Beep:

This option allows the user to specify a time interval that the buzzer will beep once to remind the user that the monitor is on. If zero is entered for the time interval, then the comfort beep feature is disabled.

Back Light:

This option allows the user to enter a time out period so that the back light will be turned off automatically after the time out period.

Clock from PC:

This option allows the PC clock to be downloaded to the MiniRAE 2000 monitor so that the user does not need to manually set the clock in the MiniRAE 2000 monitor.

Alarm Mode:

This option allows the alarm to be either **latched** or **auto-reset**. Selecting the **auto-reset** option allows the monitor to turn off alarms when the alarm situation is no longer exist. The **latched** option allows the alarm to stay on as long as the alarm situation is no longer exist and a key is pressed to acknowledge the alarm situation.

Power On Zero:

This option allows the monitor to perform a fresh air calibration automatically when the monitor is turned on. Care must be taken, when using this mode, to ensure that the monitor is in a fresh air environment and the unit has been warmed up when turned on.

Datalog Interval:

The datalog interval is the rate at which datalog samples are recorded while the datalog is running. The unit of datalog interval is second. The datalog interval determines how often a new sample is calculated and stored to the datalog.

Datalog Selection:

User can choose one or more values for datalogging purpose. User can choose to datalog the minimum, average, and maximum values, or any combinations of the three values.

Datalog Mode:

This may be set to either of four choices:

- With **Automatic start/stop**, the datalogging begins when the monitor is turned on and ends when it is turned off.
- With **Manual start/stop**, the datalog can begin by a series of key presses in the menu of normal operation. The maximum run time determines an automatic end to the datalog or it can be stopped manually.
- If **Periodic start /stop** (or daily) mode is chosen, the user must specify the start and stop hour and minute. The interval between start and stop is the period of time the monitor will datalog (at “datalogging period” rate).

-- With **Scheduled start/stop**, all the entry boxes for year, month, day, hour and minute for both start and stop time must be entered to specify when the datalog is to occur.

Run Time:

If **manual start/stop** mode for datalogging is chosen, the user needs to specify a maximum run time. After the monitor has been on for the specified run time, datalogging will be turned off automatically.

Start Time and Stop Time:

If **scheduled start/stop** mode is chosen for datalogging, all entry boxes must be completed for start and stop year, month, day, hour and minute. The monitor must already be turned on. Then once the start date/time is reached, the monitor will start datalogging. When the stop date/time is reached, the datalogging will stop automatically. With **periodic start/stop** mode, the hours and minutes are used for the datalog period to be run each day.

OK/Cancel:

When the configuration changes are completed, click on the **OK** button to save the configuration and return to the client window, or click on the **Cancel** button to abort the configuration changes.

In the **Gas Parameters** tap, the user can change alarm limits, correction factors, etc. To perform the same function as in Section 4.4.3 to 4.4.5.

In the **Others** tap, the user can put in a power-on-customized name. The name will be displayed when the unit is powered on.

5.5.2 Send Configuration to the MiniRAE 2000

After the configuration data file is opened by the ProRAE-Suite software, the user can send the configuration settings to the MiniRAE 2000 monitor. To send the configuration settings to the instrument, click **Communication->Send Config** menu item or click the **Send** toolbar icon (right arrow with “Send” letters), a message box will appear to remind the user to connect the instrument to the PC through the serial port. After making sure that the instrument is connected to the PC and ready for communication, click the **OK** button to start the data transfer.

After the configuration information is sent successfully, a message box will appear to indicate that the configuration sending process is completed. Click the **OK** button to close the message box.

If the communication is not successful, an error message indicating that there is no response from the instrument will appear. Check the cable to make sure that the connectors on both ends of the cable are securely seated in the sockets and the unit is set to communication ready mode, then try to send the configuration again. If the error message still appears after repeated attempts, call an authorized service center for help.

5.5.3 Saving Configuration Data

In order to save the configuration information for future use, click **File->Save** or **File->Save As** menu item to save the opened configuration data to a file. Once the configuration file is saved on disk, it can be opened at a later time for further modification or can be sent to the MiniRAE 2000 monitor.

5.5.4 Configuring All Settings

A user can use this function to update the entire configuration settings (except the instrument ID, serial number and the datalog option) in the MiniRAE 2000 monitor. To configure all the settings in the instrument, click the **Option->Config All** menu item, and a message box will appear to remind the user to connect the instrument to the PC through the serial port. After making sure that the instrument is connected to the PC, click the **OK** button. Another message box will appear to warn the user that this operation will erase all the current configuration settings in the monitor. If the user does not want this to happen, click the **Cancel** button, otherwise click the **OK** button to start the data transfer.

After the information is sent successfully, a message box will appear to indicate that the sending configuration process is completed. Click the **OK** button to close the message box.

Warning: The **Config All** option is mainly used to restore the MiniRAE 2000 monitor's default operational settings when the configuration of the unit is non-recoverable and the unit is malfunctioning. Because the default parameters are not normally fit a specific unit, a user will need to re-calibrate, re-set lamp and pump thresholds, re-set LCD contrast, etc. Try not to use this function if possible.

5.6 Processing the Logged Data

The ProRAE-Suite software allows the user to retrieve the logged data from the MiniRAE 2000 monitor and display the data in many different formats. The user can also export the displayed text to a tab delimited text file so that a spreadsheet program such as Microsoft Excel can read it directly.

5.6.1 Receiving Data

To receive the logged data from the MiniRAE 2000 monitor, click the **Communication->Receive Data** menu item or click the **Receive Data** toolbar button (left arrow with “Recv” letters). A message box will appear to remind the user to connect the instrument to the PC through the serial port. After making sure the instrument is connected to the PC, click the **OK** button to start the data transfer. After the data transfer is finished, a new client window is opened with the newly received logged data displayed. To save the logged data to a file for future use, click the **File->Save** or **File->Save As** menu item.

5.6.2 View Logged Data in Text Mode

Once the user opens a data file or receives the logged data from the instrument, a data window appears, as shown in Figure 5-8.

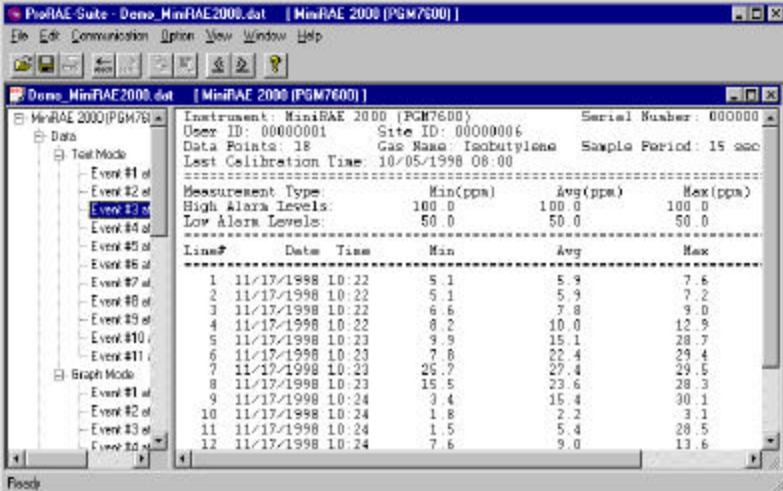

Instrument: MiniRAE 2000 (PGM7600) Serial Number: 000000
 User ID: 00000001 Site ID: 00000006
 Data Points: 18 Gas Name: Isobutylene Sample Period: 15 sec
 Last Calibration Time: 10/05/1998 08:00

Measurement Type: Min(ppm) Avg(ppm) Max(ppm)
 High Alarm Levels: 100 0 100 0 100 0
 Low Alarm Levels: 50 0 50 0 50 0

Line#	Date	Time	Min	Avg	Max
1	11/17/1998	10:22	5.1	5.9	7.6
2	11/17/1998	10:22	5.1	5.9	7.2
3	11/17/1998	10:22	6.6	7.8	9.0
4	11/17/1998	10:22	8.2	10.0	12.9
5	11/17/1998	10:23	9.9	15.1	28.7
6	11/17/1998	10:23	7.8	22.4	29.4
7	11/17/1998	10:23	26.7	27.4	29.5
8	11/17/1998	10:23	15.5	23.6	28.3
9	11/17/1998	10:24	3.4	15.4	30.1
10	11/17/1998	10:24	1.8	2.2	3.1
11	11/17/1998	10:24	1.5	5.4	28.5
12	11/17/1998	10:24	7.6	9.0	13.6

Figure 5-8 Displayed Logged Data

The data window is a two-pane client window. The left pane is a tree view that lists all the display formats of each event, and the right pane displays the information according to the display format and the event the user selected on the left pane. To select any display format of any event, simply click the format item on the left pane. To view the next event or the previous event, click the **Next Event** (double right arrow) or the **Previous Event** (double left arrow) toolbar buttons. The user can also drag the splitter bar between the left pane and the right panel to the left or to the right to enlarge a pane as desired.

To view the data points of a specific event, click the item representing that event under the item **Text Mode**. For example, click the item **Event #3** on the left pane, and the right pane displays the data points of Event #3, as shown in Figure 5-8.

5.6.3 View STEL/TWA/AVG Value

To view the STEL, TWA or AVG value of any event, click the event number item under the tree item **STEL/TWA/AVG** in the left pane. The right pane displays the STEL, TWA and AVG value of each data point of that event, as shown in Figure 5-9.

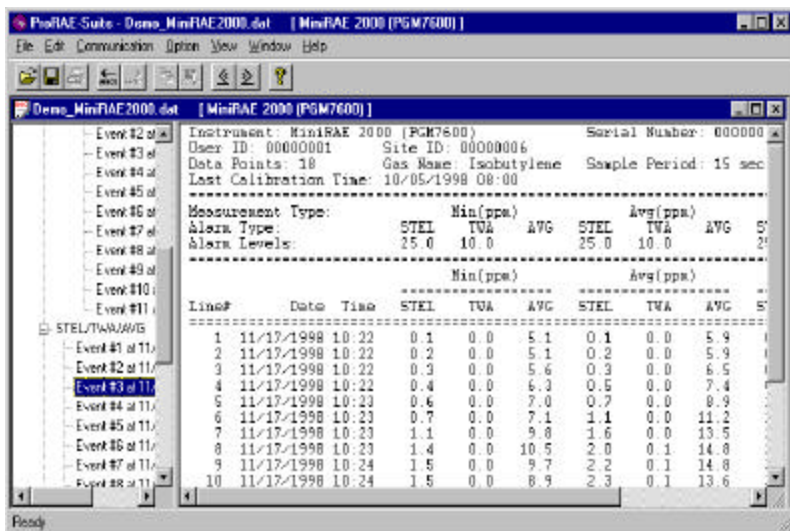

Figure 5-9 STEL/TWA/AVG of the Logged Data

5.6.4 View Summary Information

To view the summary information of any event, such as peak value and minimum value, click the event number item under the tree item **Summary** in the left pane. The right pane displays the summary information of that event, as shown in Figure 5-10.

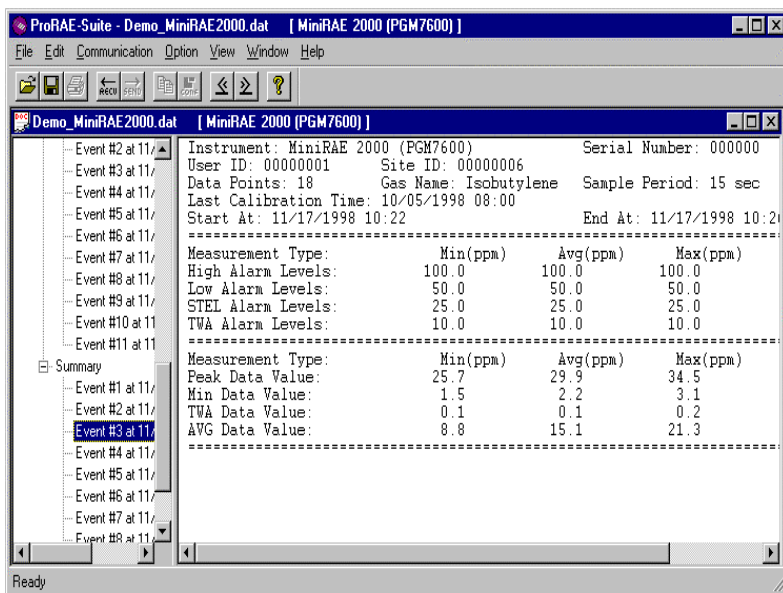

Figure 5-10 Summary Information of the Logged Data

5.6.5 View Logged Data in Graph Mode

To view the logged data of a specific event in graph mode, click the event item under the tree item **Graph Mode** in the left pane, and the right pane displays the graph of that event, as shown in Figure 5-11.

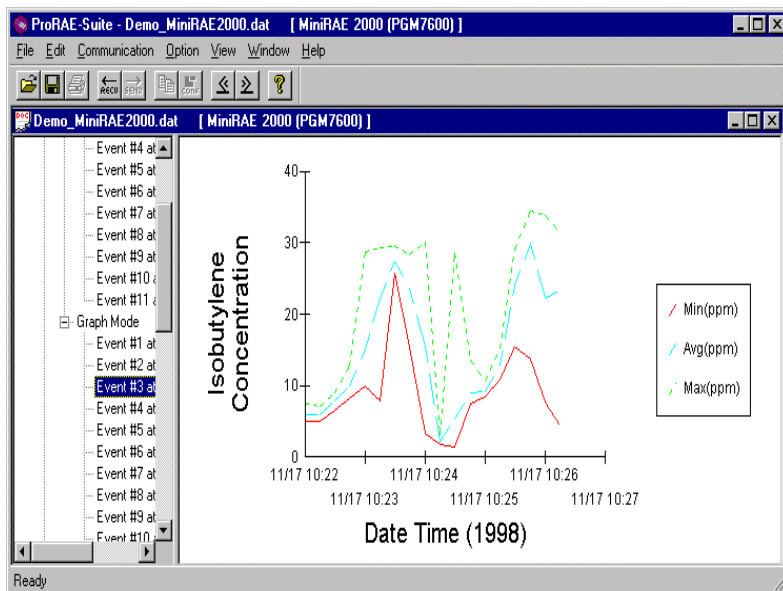

Figure 5-11 Graph of the Logged Data

Select graph type:

The user can choose the type of data in the **Graph Type** tab page of the **Graph Settings** dialog box. To display the **Graph Settings** dialog box, click any place in the right pane so that pane is active, then click the **Option->Graph Settings** menu item to display the **Graph Settings** dialog box. Figure 5-12 shows the **Graph Type** tab page of the **Graph Settings** dialog box.

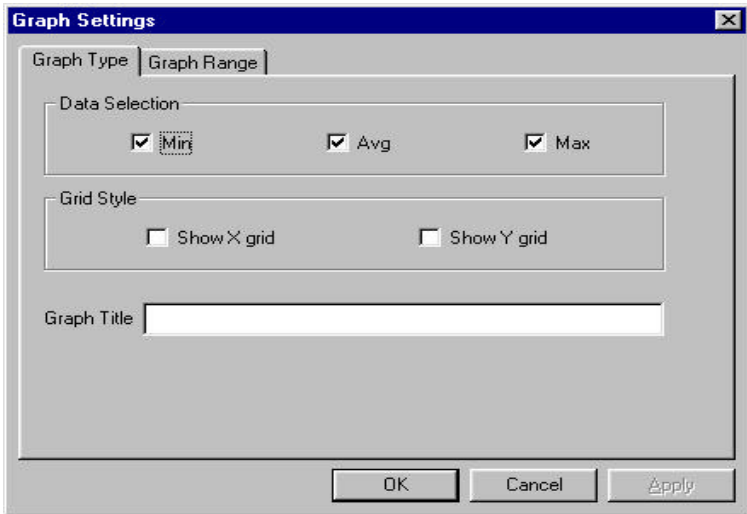

Figure 5-12 Graph Type Tab Page

Select graph range:

User can choose the value range on the x-axis and y-axis in the **Graph Range** tab page of the **Graph Settings** dialog box. To display the **Graph Settings** dialog box, click any place in the right pane so that pane is active, then click the **Option->Graph Settings** menu item to display the **Graph Settings** dialog box. To activate the **Graph Range** tab page, simply click the page header of the **Graph Range** tab page. Figure 5-13 shows the **Graph Range** tab page of the **Graph Settings** dialog box. The graph ranges for the x-axis and y-axis are then entered on this screen.

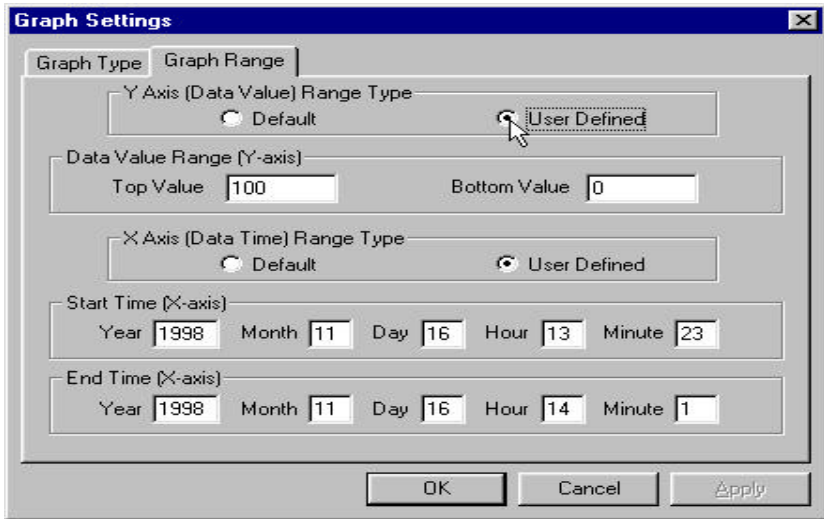

Figure 5-13 Graph Range Tab Page

To choose the range of Y-axis, first click the **User Defined** button in the **Y-Axis (Data Value) Range type** group box, then specify the top value and the bottom value in the **Data Value Range (Y-axis)** group box.

If the user selects the **Default** button in the **Y-Axis (Data Value) Range type** group box, the ProRAE-Suite software will scale the range of Y-axis by itself to cover the maximum data value on the y-axis.

To choose the range of X-axis, first click the **User Defined** button in the **X-Axis (Data Time) Range type** group box, then enter the start time values in the **Start Time (X-axis)** group box and the end time values in the **End Time (X-axis)** group box.

If the **Default** button is selected in **the X-Axis (Data Time) Range** group box, ProRAE-Suite will scale the range of X-axis by itself to cover the every data point on x-axis.

5.6.6 Exporting Data to a Text File

The ProRAE-Suite software allows the user to export the displayed text to a tab delimited text file so that a spreadsheet program such as Microsoft Excel[®] can read it directly. To export the text displayed in the right pane, click **Option -> Export Text** menu item, and a **Save As** dialog box is displayed. Specify the file name in the **File name** field and then click the **Save** button.

5.6.7 Exporting Graphics to a File

The ProRAE-Suite software allows the user to export the displayed graph to a windows bitmap (.bmp) file or a windows metafile (.wmf) file. To export the displayed graph in the right pane, first click any place in the right pane to activate that pane, then click the **Option -> Export Graph menu** to display a **Save As** dialog box. Select the export graph file type (.bmp or .wmf) in the **Save as type** field, and then specify the export file name in the **File name** field. Click **Save** to close the **Save As** dialog box. The newly created graph file contains the graph displayed in the right pane.

5.6.8 Printing Logged Data

After viewing the data results, the user may print the data in order to obtain a hard copy of the text or graphic data report. First, click any place in the right pane to activate that pane, then select the **File -> Print** menu item, or click the **Print** toolbar button (a printer) to print the graphic or text data.

A printer setup dialog box will appear before the printing starts so that the paper size, orientation, printer type, etc. can be configured correctly.

5.7 Installing Datalog Capability

To upgrade to datalogging capability, open the ProRAE-Suite software. Do not open any configuration file or data file, so the ProRAE-Suite software has no client window open, as shown in Figure 5-14.



Figure 5-14 Main window of ProRAE-Suite

Click the **Option -> Enable Datalog** menu item, and a message box will appear to remind the user to connect the instrument to the PC through the serial port. After making the proper connection, click the **OK** button to start. After the ProRAE-Suite software made successful contact to the instrument, a dialog box is displayed, as shown on Figure 5-15.



Figure 5-15 Enable Datalog Dialog Box

Figure 5-15 shows that the instrument's datalog feature is currently disabled. To enable the datalog capability, click the **Enable** button, type the three digit authorization code in the **Authorization Code** field, and then click the **OK** button to close the dialog box. When the datalog option is changed, a message box will appear on the screen to let the user know that the datalog option is successfully installed. The **Authorization Code** is provided from RAE Systems when the datalog upgrade option is purchased.

5.8 Upgrade the Firmware

To upgrade the firmware in the MiniRAE 2000 monitor, open the ProRAE-Suite software. Do not open any configuration file or data file so the ProRAE-Suite software has no client window open, as shown in Figure 5.14. Click the **Option -> Load Firmware** menu item; a message box will appear to remind the user to connect the instrument to the PC through the serial port. After making the proper connection, click the **OK** button. An **Open** dialog box is displayed, as shown in Figure 5-16. Select the firmware file (.a07) to be loaded into the instrument, and click the **Open** button to start the loading process. After the firmware loading is finished, a message box will appear on the screen to let the user know that the firmware is successfully loaded into the instrument.

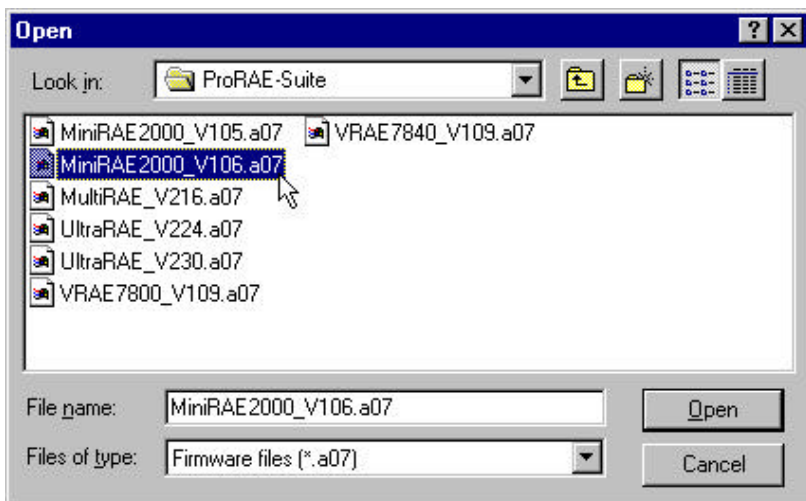

Figure 5-16 Open Firmware File Dialog Box

6. THEORY OF OPERATION

The MiniRAE 2000 monitor uses a newly developed electrodeless discharge UV lamp as the high-energy photon source for the PID. As organic vapors pass by the lamp, they are photo-ionized and the ejected electrons are detected as a current. The PID sensor with a standard 10.6 eV lamp detects a broad range of organic vapors. A lamp with high photon energy (e.g. 11.7 eV) will measure the more kinds of compounds, whereas low photon energies (e.g. 9.8 eV) are selective for easily ionizable compounds such as aromatics. In principle, any compound with an ionization energy lower than that of the lamp photons can be measured.

The PID sensor for the MiniRAE 2000 monitor is constructed as a small cavity in front of the UV lamp. A diaphragm pump draws the gas sample into the sensor and then pumps it out through the side of the instrument.

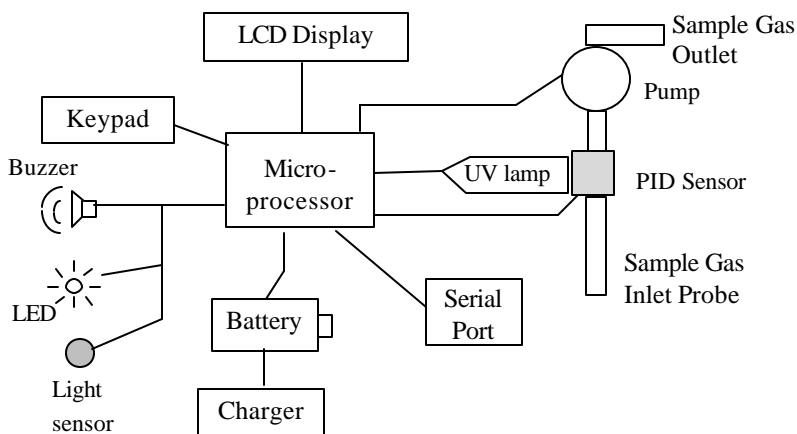

Figure 6-1 MiniRAE 2000 Block Diagram

A single chip microcomputer is used to control the operation of the alarm buzzer, LED, pump and light sensor. It measures the sensor readings and calculates the gas concentrations based on calibration to known standard gases. The data are stored in non-volatile memory so that they can be sent to a PC for record keeping. RS-232 transceivers provide a serial interface between the monitor and the serial port of a PC. An LCD display consisting of a single row of eight alpha/numeric characters is used to display the readings. The user interacts with the monitor through three keys on the front panel keypad.

A rechargeable NiMH, NiCd battery, or an alkaline battery pack powers the monitor.

7. MAINTENANCE

The major maintenance items of the MiniRAE 2000 are:

- Battery pack
- Sensor module
- PID lamp
- Sampling pump
- Inlet connectors and filters

Note: Maintenance should be performed by qualified personnel only.

NOTE: The printed circuit board of the monitor is connected to the battery pack even if the power is turned off. Therefore, it is very important to disconnect the battery pack before servicing or replacing any components inside the monitor. Severe damage to the printed circuit board or battery may occur if the battery pack is not disconnected before servicing the unit.

7.1 Battery Charging and Replacement

When the display shows a flashing message “Bat”, the battery requires recharging (see Section 3.1 for Battery charging). It is recommended to recharge the MiniRAE 2000 monitor upon returning from fieldwork. A fully charged battery runs a MiniRAE 2000 monitor for 10 hours continuously. The charging time is less than 10 hours for a fully discharged battery. The built-in charging circuit is controlled by the micro-controller to prevent over-charging. The battery may be replaced in the field (in area known to be non-hazardous) if required.

WARNING:

To reduce the risk of ignition of hazardous atmospheres, recharge battery only in area known to be non- hazardous. Remove and replace battery only in area known to be non- hazardous.

Replacing Battery Pack

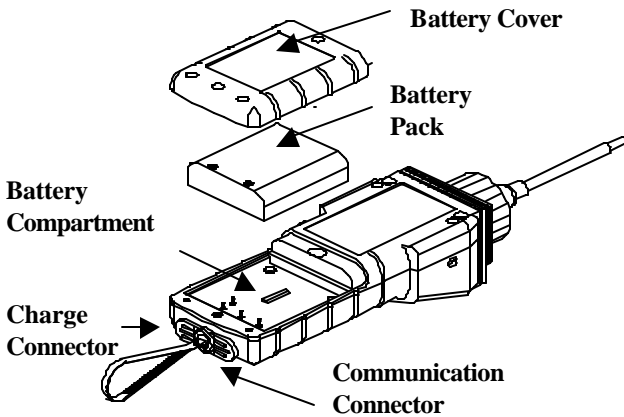

Figure 7-1 Battery Replacement

1. Turn off the power of the MiniRAE 2000.
2. Unscrew the two battery compartment screws, located on the bottom of the monitor, and remove the cover.
3. Remove the battery pack from the battery compartment.
4. Replace a fully charged spare battery pack inside the battery compartment. Make sure the battery pack is oriented properly inside the compartment
5. Close the battery cover and tighten the two screws.

Replacing Alkaline Battery Adapter

1. Insert four fresh AA size alkaline batteries into the alkaline battery holder. Make sure that the polarity of the batteries is correct.
2. Follow the same procedure as described above to replace the battery holder.

Note: The internal charging circuit is designed to prevent charging to alkaline batteries.

7.2 PID Sensor & Lamp Cleaning / Replacement

The sensor module is made of several components and is attached to the lamp-housing unit as shown in Figure 7-2.

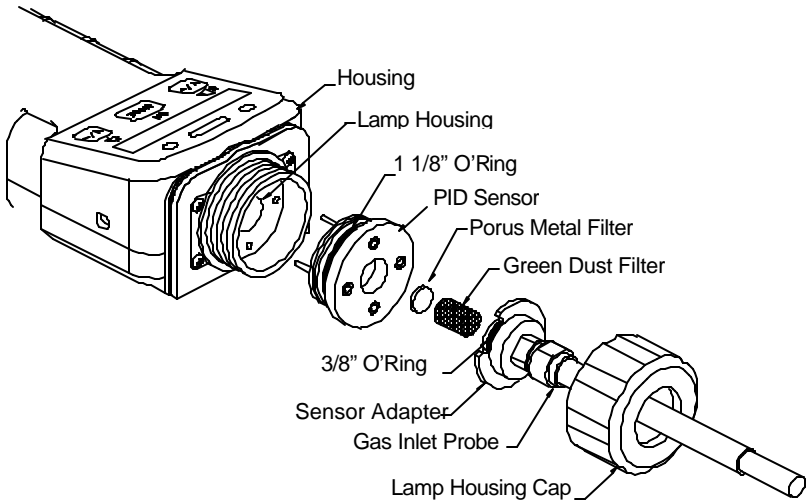

Figure 7-2 Sensor Components

Note: Normally the cleaning procedure is not needed. Clean the PID sensor module, the lamp and the lamp housing only when one of the following happened:

1. The reading is inaccurate even after calibration.
2. The reading is very sensitive to air moisture.
3. A chemical liquid has been sucked into the unit and damaged the unit.

Use of the water trap filter will help prevent contamination and accidentally drawing liquid into the sensor.

To access the sensor components and lamp, gently unscrew the lamp-housing cap, remove the sensor adapter with the gas inlet probe and the metal filter all together. Then hold the PID sensor and pull straight out to avoid bending the electrical pins on the sensor (see Figure 7-2). A slight, gentle rocking motion helps release the sensor.

To clean the PID sensor:

Place the entire PID sensor module into GC grade methanol. It is highly recommended that an ultrasound bath to be used to clean the sensor for at least 15 minutes. Then dry the sensor thoroughly. Never touch the electrodes of the sensor by hand.

Also use a methanol-soaked cotton swab to wipe off the lamp housing where it contacts the sensor when the sensor is installed.

Turn over the sensor so that the pins point up and the sensor cavity is visible. Examine the sensor electrodes for any corrosion, damage, or bending out of alignment. The metal sensor electrode “fingers” should be flat and straight. If necessary, carefully bend the sensor fingers to ensure that they do not touch the Teflon portions and that they are parallel to each other. Make sure that the nuts on the sensor pins are snug but not overtight. If the sensor is corroded or otherwise damaged, it should be replaced.

To clean lamp housing or change the lamp:

If the lamp does not turn on, the monitor will display an error message (Lamp) to indicate replacement of the lamp may be required.

1. If the lamp is operational, clean the lamp window surface and the lamp housing by wiping it with GC grade methanol using a cotton swab with moderate pressure. After cleaning, hold the lamp up to the light at an angle to detect any remaining film. Repeat the process until the lamp window is clean. Never use water solutions to clean the lamp. Dry the lamp and the lamp housing thoroughly after cleaning.

CAUTION: Never touch the window surface with fingers or anything that may leave a film. Never use acetone or aqueous solutions, especially on 11.7 eV lamps.

2. If the lamp does not turn on, remove the UV lamp from the lamp housing. Place the lamp O-ring onto the new lamp. Insert the new lamp, avoiding contact with the flat window surface.
3. Reinstall the PID sensor module.
4. Tighten the Lamp Housing Cap.
5. If the lamp type has been changed, adjust the lamp type setting in the programming mode (Section 4.7.8). When changing between 10.6 eV and 9.8 or 11.7 eV lamps, it may be desirable to adjust the lamp drive (LDRV) and lamp fail threshold in diagnostic mode (see Section 8).

7.3 Sampling Pump

When approaching the end of the specified lifetime of the pump, it will consume higher amount of energy and reduce its sample draw capability significantly. When this occurs, it is necessary to replace or rebuild the pump. When checking the pump flow, make sure that the inlet connector is tight and the inlet tubing is in good condition. Connect a flow meter to the gas inlet probe. The flow rate should be above 450 cc/min when there is no air leakage.

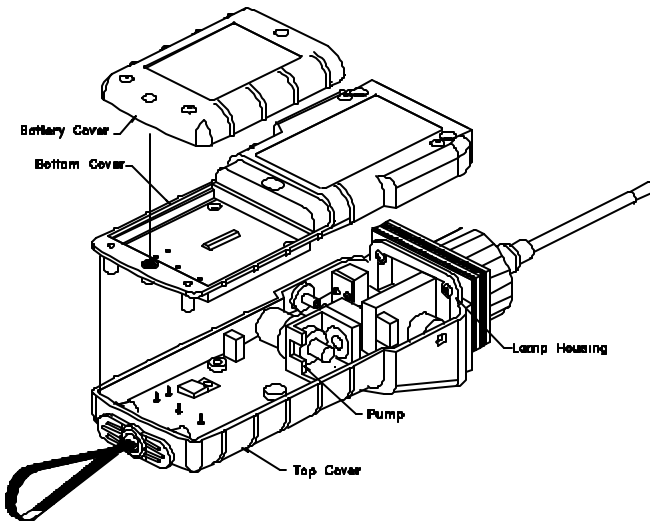

Figure 7-3 Sampling Pump

Pump Replacement

1. Turn off the MiniRAE 2000 power.
2. Open the battery cover, remove the battery pack, and carefully unscrew the six screws to open the bottom cover.
3. Unplug the pump from the PCB. Unscrew the two screws that hold the pump assembly to the PCB. Disconnect the Tygon tubing that connects the pump to the gas inlet port and gas outlet port.
4. Insert a new pump assembly. Connect the Tygon tubing to the gas inlet port. Plug the pump connector back into the PCB and screw down the pump assembly to the board.
5. Replace the bottom cover and tighten the six screws. Re-connect the battery pack. Replace the battery pack and its cover.

7.4 Turning on the UV Lamp

The UV lamp is made of a glass envelope and a UV window (salt crystal) on one end of the envelope. The inside of the lamp is filled with low pressure gases. To turn on the lamp, a high voltage electric field is applied from the outside of the glass envelope. The molecules inside the lamp are ionized and produce a glow discharge that generates the UV light. The MiniRAE 2000 has a built-in sensing mechanism to monitor the status of the UV lamp and display a “Lamp” error message if it is not on.

If the UV lamp has not been used for a long period of time (> 1 month), it may become slightly harder to turn on. If such a condition occurs, the “Lamp” message will appear in the monitor display during the power on sequence. This phenomenon is more significant in 0.25” UV lamps used in ToxiRAE and MultiRAE Plus products, because of the relatively small lamp size. To solve this problem, simply turn on and off the monitor a few times and the lamp should turn on. Gently shaking the monitor will also help to initiate the glow discharge process. After the UV lamp is turned on for the first time, it should be easier to turn on the UV lamp next time.

It is possible that the UV lamp is actually on when the lamp error message appears. This is because when the lamp becomes old, the internal threshold level to detect lamp failure may have shifted and cause a false alarm. To eliminate such possibility, simply check to see the UV lamp is actually on. This can be done easily by removing the sensor cap and observing the glow light of the UV lamp in a dark place. The user can also feed the monitor with calibration gas and observe if the sensor reading

changes. If the reading changes significantly with the gas, the UV lamp is actually on. If the UV lamp is on while the error message persists, then it is necessary to adjust the lamp threshold (See **Adjust Lamp Failure Threshold** in Chapter 8.)

It is possible to increase the Lamp Drive power for easier lamp start-up or to extend the life of the lamp. This is done by adjusting the LDRV value in Diagnostic Mode (Chapter 8). For 10.6 eV lamps this value is normally 175 and for 9.8 and 11.7 eV lamps it is set at 200. The value can be increased up to 225 if necessary, but should be returned to the standard values when a new lamp is installed to reduce the power consumption and wear on the lamp and electronics.

A possible failure mechanism for the UV lamp is a leak developed along the seal of the glass envelope. When such a condition occurs, the lamp will become very hard or impossible to turn on and will need to be replaced.

8. TROUBLESHOOTING

To aid the user in diagnosing the monitor, a special diagnostic mode can be used displays critical, low level parameters. Section 8.1 describes the operation of the diagnostic mode. Section 8.2 summarizes the frequently encountered problems and suggested solutions. By turning on the MiniRAE 2000 monitor in diagnostic mode and by using the troubleshooting table in Section 8.2, the user can usually correct the problem without having to return the monitor for repair.

WARNING: This function should be used by qualified personnel only! The diagnostic mode allows the user to set several low-level parameters that are very critical to the operation of the monitor. Extra care should be taken when setting these parameters. If the user is not familiar with the function of these parameters and sets them incorrectly, it may cause the monitor to shut down or malfunction.

8.1 Special Diagnostic Mode

To turn on the monitor to the special diagnostic mode, push and hold the **[Y/+]** key, and then push and hold the **[MODE]** key for at least two seconds (until the beep stops). After the required delay, release both keys, the monitor will go through the start-up sequence and display a “Diagnostic Mode” message. At the end of the special mode start-up, the display will show the raw counts of sensor channel 1A. These numbers are raw sensor readings without calibration.

In Diagnostic Mode the pump and lamp are normally on, and the user may enter Programming Mode and calibrate the instrument as usual by holding the **[MODE]** and **[N/-]** keys down simultaneously for 3 seconds. Once the monitor is started up in Diagnostic Mode, the user can switch between Diagnostic Mode and normal operating mode by pressing and holding down the **[MODE]** and **[Y/+]** keys simultaneously for 2 seconds.

Critical parameters of the monitor available in Diagnostic Mode are shown below. They can be reached by pressing the **[MODE]** key repeatedly until the desired parameters are displayed.

TROUBLESHOOTING

Key Action	Parameter	Display
	Raw Reading	1A 167 (+ = 10X)
[MODE]	Raw Reading	10A 188 (+ = 100X)
[Y/+]	Raw Reading	100A 310
[MODE]	Raw Reading	1B 165 not used (+ = 10X)
[MODE]	Raw Reading	10B 166 not used (+=100X)
[Y/+]	Raw Reading	100B (+=100X)
[MODE]	Lamp Current	Lamp = 143
[MODE]	Lamp Fail Level	Fail = 103 (+/-)
[MODE]	Lamp Drive	Ldrv = 175 (+/-)#
[MODE]	Battery Type	Ni-Cd/MH /Alkaline
[MODE]	LCD Contrast	Contrast (+/-) ÿÿÿÿ ____
[MODE]	Battery Duration	Battery Duration: XX:XX
[MODE]	Pump Current	Pump 7/ 7
[MODE]	Pump Stall Level	Stall 10 (+/-)
[MODE]	Pump Motor drive	Mdrv = 250 (+/-)*
[MODE]	DAC Output Count	DAC = 2048 (+/-)
[MODE]	Alarm Test	Alarm (on/off)?
[MODE]	Ambient Light Level	Lite = 237
[MODE]	Backlight Trip Level	Trip = 100 (+/-)
[MODE]	PC Comm	PC Comm?

Table 8-1 Diagnostic Mode Menu

Notes: * Do not change this setting.

The value for 9.8 eV and 11.7 eV lamps is 200, and for 10.6 eV is 175. Normally, this setting should not be changed.

Below is a brief description of the diagnostic displays:

1) Raw Sensor Readings

The raw sensor readings provide a quick diagnosis on the response and the sensitivity of the sensor. When zero gas (fresh clean air) is applied to the monitor, the raw sensor readings typically should be between 100 and 400 for 1A and 10A, 64 and 840 for 100A. If the raw reading is outside this range when zero gas is applied, the sensor or the lamp housing may be dirty or the electronics may be defective. Channel A is the PID sensor. Channel B is an auxiliary channel that is currently not used.

When a test gas is applied to the monitor, the raw readings should increase. If the reading does not change when the gas is applied, then the sensor or lamp may be defective.

2) Adjust Lamp Failure Threshold

This display can be used to calibrate the PID lamp failure threshold. If the lamp appears to be good but in normal operation a lamp failure message (i.e. "Lamp") is displayed, the lamp failure level may be set too high. This level can be adjusted by using the following steps:

1. Turn the monitor off. Remove the UV lamp from the PID sensor (see Section 7.2).
2. Turn the monitor on in the special diagnostic mode (**[Y/+]** & **[MODE]**).
3. Press the **[MODE]** key until "Lamp xxx" is displayed, write down this number. The reading "xxx" is the lamp current reading.
4. Press the **[MODE]** key one more time, "Fail yyy" is now displayed. The value "yyy" is the threshold level

that determines lamp fail. Anything below this level is considered a failure.

5. Push the **[Y/+]** or **[N/-]** key to increase or decrease the threshold value “yyy” until it is about 10 - 15 counts above the “xxx” value. This will optimally set the lamp failure threshold. Press **[MODE]** key to exit this display. If the threshold value has changed, a message “Save?” will appear. Press **[Y/+]** to confirm the change, **[N/-]** or **[MODE]** key to abandon the changes.
6. Turn the monitor off and replace the lamp.
7. To verify the above adjustment, turn the monitor back on in Diagnostic Mode and press the **[MODE]** key until “Lamp xxx” is displayed. Press the **[MODE]** key once more so that “Fail yyy +/-” is displayed. The lamp current reading “xxx” should be higher than the threshold value “yyy” by at least 10-15 counts. If not, the lamp may be defective or very weak.

In most cases lamp failure threshold adjustment is not required, in which case the user should press **[MODE]** to exit this display.

3) Lamp Drive: For 10.6 eV lamps this value is normally 175 and for 9.8 and 11.7 eV lamps it is set at 200. The value can be increased up to 225 if necessary, but should be returned to the standard values when a new lamp is installed to reduce the power consumption and wear on the lamp and electronics.

4) Battery Type

The MiniRAE 2000 monitor can be powered by either a rechargeable nominal 4.8V NiMH / NiCd battery pack or an alkaline battery holder. This display shows the type of battery, which is currently installed in the monitor. The charger cable must be unplugged for a correct battery type display.

5) Adjust LCD Contrast

This display allows the user to adjust the LCD contrast. Press **[Y/+]** to increase the contrast and **[N/-]** key to decrease the contrast. The bar graph shows the current LCD contrast setting. If the display appears blank or very faint, press the **[Y/+]** key several times to increase the contrast or darken the display.

6) Battery Duration

This display shows the run time of the last time the unit powered itself off due to a low battery or turned off by the user. It is useful for battery life testing.

7) Adjust Pump Stall Threshold

This display can be used to calibrate the pump stall threshold. If the gas inlet is blocked but the pump does not shut down, or the pump shuts down too easily with a slight blockage, the pump stall threshold value may be set too high or too low. Use the following steps to adjust the pump stall threshold.

1. In diagnostic mode, press the **[MODE]** key until "Pump xxx/yyy" is displayed. This is the maximum and average pump current under normal conditions.

2. Block the gas inlet and watch the pump current readings increase. Write down the blocked reading. If the pump current reading does not increase significantly (i.e. more than 10 counts), then there may be a leak in the gas inlet or the pump is weak or defective. Press the **[MODE]** key one more time, the display should show the message “Stall yyy”.
3. Use the **[Y/+]** or **[N/-]** key to increase or decrease the stall value until it is the average of the maximum block count and the maximum normal (unblocked) count. Press the **[MODE]** key to exit this display. If the threshold value is changed, a message “Save?” will appear. Press **[Y/+]** to confirm the change, **[N/-]** or **[MODE]** to abandon the changes.

8) Motor Drive

This display allows the user to adjust the pump drive and thus alter the pump flow. Normally, the user should not adjust this parameter. Only minor changes are possible and the flow is not linear with the Mdrv value.

9) DAC Output Counts

The menu allows the user to check the DAC analog output using the **[Y/+]** and **[N/-]** keys. The remote alarm output signal on the serial interface cable is deselected and the analog output signal is selected in its place. This signal has a range of 0 to 2.5V in 4096 steps. The initial default output is 2048, or 1.25V. See Figure 8-1 for signal pin-out. The user can attach a voltmeter to check the analog voltage output. (Adjustment of the DAC range is done in the normal program mode).

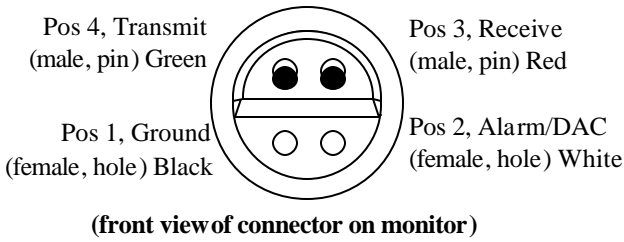

Figure 8-1 Communication/Alarm Connector

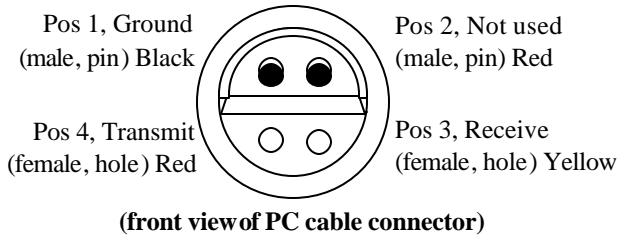

Figure 8-2 Communication/Alarm Cable

To prepare a cable to obtain a continuous voltage output proportional to the sensor signal, reconnect a wire from position 3 or 4 on the cable to position 2 on the cable. Use position 1 for the signal ground.

10) Alarm Test

This menu is used to test the monitor's alarms, including the four LED's, the buzzer, and the vibrator output signal (remote alarm). The message "Alarm" is first displayed, followed by "On?" If the **[Y/+]** key is pressed at this point, the alarms will turn on and the message "Off?" will appear. Press the **[Y/+]** key again to turn the alarms off. Check external alarm signal at connector.

11) Adjust Back Light Threshold

This display can be used to calibrate the LCD back light turn on and off threshold. Use the following steps to adjust the back light threshold.

1. The “Lite = xxx” message displays the present ambient light level incident on the face of the monitor. In a brightly-lit room, the light reading should be above 130.
2. The user can shade the light sensor, which is located at the upper left corner of the monitor, with their hand and watch the light sensor reading. The light reading should drop to less than 100. Press the **[MODE]** key one more time, the display should show the message “Trip= 100”.
3. Use the **[Y/+]** or **[N/-]** key to increase or decrease the trip value until it is 100. Press **[MODE]** to exit this display. If the threshold value is changed, a message “Save?” will appear. Press **[Y/+]** to confirm the change, **[N/-]** or **[MODE]** to abandon the changes.

8.2 Troubleshooting Table

Table 8-2

Problem	Possible Reasons & Solutions
Cannot turn on power after charging the battery	<p>Reasons: Discharged battery. Defective battery. Microcomputer hang-up.</p> <p>Solutions: Charge or replace battery. Disconnect, then connect battery to reset computer.</p>
No LCD back light	<p>Reasons: Trigger level too low, the current mode is not user mode, and the mode does not support automatic turn on back light.</p> <p>Solutions: Adjust trigger level. Verify the back light can be turned on in user mode. Call authorized service center.</p>
Lost password	<p>Solutions: Use default configuration to reset password from computer. Warning: If the default configuration is loaded, all the parameters need to be reset, including pump, lamp and LCD contrast thresholds, serial number; and re-calibration is required.</p>
Reading abnormally High	<p>Reasons: Dirty sensor module. Dirty water trap filter. Excessive moisture and water condensation.</p> <p>Solutions: Clean sensor module and lamp housing. Replace water trap filter. Blow dry the sensor module.</p>

TROUBLESHOOTING

Problem	Possible Reasons & Solutions
Buzzer Inoperative	<p>Reasons: Bad buzzer.</p> <p>Solutions: Call authorized service center.</p>
Inlet flow too low	<p>Reasons: Pump diaphragm damaged or has debris. Flow path leaks.</p> <p>Solutions: Check flow path for leaks; sensor module O-ring, tube connectors, Teflon tube compression fitting. Replace pump or diaphragm.</p>
“Lamp” message during operation	<p>Reasons: Lamp drive circuit. Lamp threshold set too high. Weak or defective PID lamp, defective.</p> <p>Solutions: Check and reset lamp threshold Replace the UV lamp</p>
Full scale measurement in humid environment	<p>Reasons: Dirty or wet sensor.</p> <p>Solutions: Clean and dry sensor and lamp housing. Adjust sensor fingers to ensure not touching Teflon. Use water trap filter.</p>
Reading abnormally low	<p>Reasons: Incorrect calibration. Low sensitivity to the specific gas. Weak or dirty lamp. Air leakage.</p> <p>Solutions: Calibrate the monitor. Replace sensor. Clean or replace lamp. Check air leakage.</p>

TROUBLESHOOTING

Problem	Possible Reasons & Solutions
Read a small background value	<p>Reasons: There is actually a small background gas level. Sensor zero drift.</p> <p>Solutions: Do fresh air calibration (see Section 4.4.1).</p>
Reading jumping around randomly	<p>Reasons: Incorrect calibration gas value. Low sensitivity to cal gas. Weak or dirty lamp . Air leakage.</p> <p>Solutions: Calibrate the sensor. Use different cal gas. Clean or replace lamp . Check air leakage.</p>
Cannot turn off monitor or corrupted characters in LCD display	<p>Reasons: Microprocessor hang-up</p> <p>Solutions: Disconnect and re-connect battery to reset computer. Call authorized service center.</p>
“Bat” message in operation	<p>Reasons: Discharged battery .</p> <p>Solutions: Recharge battery .</p>
Excessive pump noise or no inlet air suction	<p>Reasons: Blocked inlet path. Defective pump .</p> <p>Solutions: Check inlet connection. Check pump .</p>
Calibration error message	<p>Reasons: No standard gas input. Weak PID lamp . Unit zeroed with gas present.</p> <p>Solutions: Make sure standard gas flows into monitor. Zero sensor & recalibrate. Replace lamp.</p>

**APPENDIX A.
QUICK REFERENCE GUIDE**

PROGRAMMING MODE

Calibrate/Select Gas?

Fresh air cal?
Span cal?
Select cal memory?
Change span value?
Modify cal memory?
Change correction factor?

Change Alarm Limits?

High limit?
Low limit ?
STEL limit?
TWA limit?

View/Change Datalog?

Reset Peak/Minimum?
View data?
Clear data?
Change data period?
Change average type?

Change Monitor Setup?

Change Op Mode?
Change Site ID?
Change User ID?
Change Alarm Mode?
Change User Mode?
Change Date?
Change Time?
Change Lamp?
Change Unit?
Change Dilution Ratio?
Change Output?
Change DAC Range?
Set Temperature Unit?

APPENDIX B

APPENDIX B. EXPENDABLE AND REPLACEMENT PART LIST

The replacement part number of the standard expendables and common repair parts are listed in the table below:

Table B-1

Part Number	Part Description
012-3051	Ni-MH battery pack
012-3052	Alkaline battery holder
490-0047-000	Porous metal filter
012-2027-000	Lamp housing cap
017-2011-000	Sensor Adapter
050-0020-000	½", 9.8 eV electrode-less UV lamp
050-0000-000	½", 10.6 eV electrode-less UV lamp
050-0001-000	½", 11.7 eV electrode-less UV lamp
500-0003	3 3-liter Tedlar bag
002-3008	Organic vapor zero kit
012-3007	PID sensor assembly
012-3017	Housing top
012-3018	Housing bottom
012-2042	Lamp housing gasket
002-3009	Hard transport case
008-3003	Computer interface cable
081-0008	Tool kit
310-0012-060	Pump
081-0006-000	Pump rebuilt kit

**APPENDIX C.
RAE SYSTEMS TECHNICAL NOTES**

- ▶ TN-102 Facts About PID Measurement
- ▶ TN-103 External Datalogger Interface to MiniRAE PID
- ▶ TN-104 Partial List of Ionization Potentials
- ▶ TN-105 MiniRAE PID Battery Characteristics
- ▶ TN-106 Correction Factors, Ionization Potentials, and Calibration Characteristics
- ▶ TN-108 MiniRAE PLUS PGM-76 and 76IS ProRAE 76 Software Upgrade for PGM-75
- ▶ TN-109 MiniRAE Professional PID Zero Drift
- ▶ TN-112 MiniRAE PLUS Datalogger Data Conversion to Microsoft Excel version 5.0
- ▶ TN-113 Calibration Procedures for ModuRAE PDM-10A
- ▶ TN-114 ToxiRAE Sensor Specifications
- ▶ TN-115 ToxiRAE Toxic Gas Monitor (PGM-35) at a Glance
- ▶ TN-116 ToxiRAE Oxygen Monitor (PGM-36) at a Glance
- ▶ TN-117 ToxiRAE Combustible Gas Monitor (PGM-37) at a Glance
- ▶ TN-118 Use of RAE PIDs for Soil Headspace Measurements
- ▶ TN-119 Calculation of STEL, TWA, Min., Max., and Average Values for ToxiRAE PID.
- ▶ TN-120 Measuring Correction Factors for Volatile Compounds with MiniRAE 7 and ToxiRAE PIDs
- ▶ TN-121 CO Sensor Cross-Sensitivity and Removal with Charcoal Filter
- ▶ TN-122 MiniRAE Compliance with EPA Method 21
- ▶ TN-123 Diagnostic Modes for RAE Instruments
- ▶ TN 124 PID Lamp Characteristics
- ▶ TN 125 Creating Custom Correction Factors and Gas Names for the ToxiRAE PID
- ▶ TN-126 Interchangeability of Sensors in PGM-35 and PGM-50
- ▶ TN-127 Benzene-Specific Measurements in Petroleum Hydrocarbons using the UltraRAE
- ▶ TN-128 ToxiRAE PID Communications Problems
- ▶ TN-130 Setting Alarm Limits for Mixtures
- ▶ TN-131 Verifying and Fixing Gas Alarm Limits

APPENDIX C

- ▶ TN-132 Upgrading RAE Instruments Firmware
- ▶ TN-133 Methylene Chloride-Specific Measurements using the UltraRAE
- ▶ TN-134 UltraRAE Bar Code Reader Patterns and Adjustments
- ▶ TN-135 UltraRAE Firmware & Tube Data Upgrade Procedures
- ▶ TN-136 UltraRAE Operations Tips
- ▶ TN-137 Exiting Diagnostic Mode for ToxiRAE LEL
- ▶ TN-138 RAE System Year 2000 Compliance
- ▶ TN-139 UltraRAE Communication with NT
- ▶ TN-140 Extension Tubing Volume and Delay Time
- ▶ TN-141 MultiRAE Remote Control Functions
- ▶ TN-142 MiniRAE 2000 Preprogrammed Compound Library
- ▶ TN-143 Accuracy Comparisons of Gas Detection Tubes
- ▶ TN-144 Handling LEL Sensor Poisoning
- ▶ TN-145 Proper Care of Nickel Cadmium Battery Packs
- ▶ TN-146 Turning On UV Lamps in a PID Monitor
- ▶ TN-147 UltraRAE: Butadiene Specific Monitor
- ▶ TN-148 Measurement of Phosphine (PH₃) by PID In the Food Storage industry
- ▶ TN-149 PGM-30 UV Lamp Care
- ▶ TN-150 Understanding the ppbRAE
- ▶ TN-151 Electrochemical Sensor Replacement and Maintenance
- ▶ TN-152 Effects of Operating Conditions on Oxygen Sensors
- ▶ TN-153 TC Sensor Applications and Correction Factors
- ▶ TN-154 SampleRAE Correction Factors
- ▶ TN-155 2-Year Oxygen Sensor Installation and Calibration
- ▶ TN-156 Correction Factors for Combustible Gas (LEL) Sensors
- ▶ TN-157 Moisture Exchange Tubes for Humidity Control of Test Gases
- ▶ TN-158 Conversion of PID Readings to Methane Equivalent Response
- ▶ TN-159 Nerve Agent Measurements by PID
- ▶ TN-160 Upgrading MultiRAE/QRAE Ni-Cd Battery Pack

Technical Notes are available at www.raesystems.com.
See Appendix E to order hard copies of Technical Notes.

APPENDIX D.
RAE SYSTEMS APPLICATION NOTES

- ▶ AP-200 PIDs and Aircraft Wing-tank Entry
- ▶ AP-201 Measuring Ammonia (NH₃) with PIDs
- ▶ AP-202 ABCs of Gases in Industry
- ▶ AP-203 PID as a Hazmat Response Tool
- ▶ AP-204 Pulp & Paper: Measuring Turpentine & ClO₂
- ▶ AP-205 Measuring Heat Transfer Fluids with a PID
- ▶ AP-206 Guide to Atmospheric Testing in a Confined Space
- ▶ AP-207 PIDs as an Arson Investigation Tool
- ▶ AP-208 HAZMAT User List
- ▶ AP-209 UltraRAE User List
- ▶ AP-210 North American RAE User List
- ▶ AP-211 PIDs for Continuous Monitoring of VOCs
- ▶ AP-212 PIDs for Indoor Air Quality
- ▶ AP-213 ModuRAE PID Configuration and Applications
- ▶ AP-214 Environmental Applications for PIDs
- ▶ AP-215 Gas Detection in the Marine Industry
- ▶ AP-216 Weapons of Mass Destruction
- ▶ AP-217 Confined Spaces in the Construction Industry
- ▶ AP-218 Lengthening the Interval Between Calibration Checks
- ▶ AP-219 Using PIDs for 10% of LEL Decisions
- ▶ AP-220 Using PIDs in Clan Lab Investigations
- ▶ AP-221 PIDs for Exposure Risk in Unknown Environments
- ▶ AP-222 CO & Natural Gas Detection for Fire Department Engine Companies
- ▶ AP-223 ppbRAE User List
- ▶ AP-224 Understanding the CDRAE and its Applications

Application Notes are available at www.raesystems.com.
See Appendix E to order hard copies of Application Notes.

APPENDIX E. LITERATURE REQUEST

Application and Technical Notes are available at www.raesystems.com in PDF format for printing.

For hard copies, Photocopy this page and fax to:

Attn: Literature Department

1.408.752.0724 FAX

Please send me the following information:

Name: _____

Company: _____

Mailing Address: _____

City, State, Zip: _____

Country: _____

Telephone: _____

Fax: _____

Technical Notes:
(just list TN #) _____

Application Notes:
(just list AP #) _____

Comments: _____

Thank you,
RAE Systems Sales & Marketing Department

**APPENDIX F. REQUEST FOR RETURN
AUTHORIZATION FORM**

**Need to send your monitor in for repair,
calibration, service or upgrading?**

For proper tracking of your equipment please obtain an **RMA
Number** before returning the monitor.

Photocopy this page and fax to Attn: Service Department:
1.408.585.3544

We will return fax the RMA Number and instructions on how to ship.

We must obtain the following information in full:

Name:

Company:

Shipping

Address:

City, State, Zip:

Telephone:

Fax:

Serial number:

Model:

Reason for
return:

Note: When returning an instrument for repair, please send only the monitor that needs to be worked on without any additional accessories. Only send accessories with the instrument when they are also in need of repair. This will help us get your equipment back to you in an efficient manner.

Thank you,
RAE Systems Service Department

RAE Systems Inc.
1339 Moffett Park Drive
Sunnyvale, California 94089

Main Contact Numbers

Telephone: 408.752.0723

Fax: 408.752.0724

Instrument Sales: 877.RAE.CUSTOMer (723-2878)

Tube Sales: 888.RAE.Tube (723.8823)

Technical Service: 408.585.3540

E-mail:

RaeSales@raesystems.com

Tech@raesystems.com

World Wide Web Site:
www.raesystems.com